

General Catalogue

Edition
No. 6



DYNAJET

Water Jetting Systems up to 3,000 bar



DYNAJET

Contents

	Water-jetting systems for professionals	4	
	DYNAJET innovations	6	
	DYNAJET throughout the world	10	
	Sectors and applications	12	DYNAJET for construction and renovation
		14	DYNAJET for local authorities
		16	DYNAJET for industry
		18	DYNAJET for shipyards and offshore
		20	DYNAJET for agriculture and forestry
350	Water-jetting systems and accessories up to 350 bar (5,075 PSI)	22	Water-jetting systems up to 350 bar
		28	Accessories up to 350 bar
500	Water-jetting systems and accessories up to 500 bar (7,250 PSI)	42	Water-jetting systems up to 500 bar
		48	Accessories up to 500 bar
1.000	Water-jetting systems and accessories up to 1,000 bar (14,500 PSI)	60	Water-jetting systems up to 1,000 bar
		66	Accessories up to 1,000 bar
3.000	Water-jetting systems and accessories up to 3,000 bar (43,500 PSI)	78	Water-jetting systems up to 3,000 bar
		82	Accessories up to 3,000 bar
	Personal protective equipment	90	
	Machines and versions lists	94	
	Contact information, demonstrations and purchase	98	



DYNAJET
Model: DYN 1000
Power: 1000 W
Voltage: 230 V
Frequency: 50 Hz
Weight: 15 kg
Dimensions: 450 x 300 x 200 mm
CE

DYNAJET
Model: DYN 1000
Power: 1000 W
Voltage: 230 V
Frequency: 50 Hz
Weight: 15 kg
Dimensions: 450 x 300 x 200 mm
CE

The no. 1 in efficiency, power and performance

Throughout the world, professionals of all sectors trust in the highly efficient water-jetting systems and accessories from DYNAJET. Our innovative high-pressure units, offering a working pressure of up to 3,000 bar (43,500 PSI), impress not only with their all-round deployability, but also with their extreme cost-effectiveness, absolute reliability and uncompromising quality.

The DYNAJET product promise

Powerful technology

As we have our own development department, you always get the latest technology in a performance spectrum ranging from 150 to 3,000 bar when you purchase a DYNAJET water-jetting system.

Maximum safety

All DYNAJET water-jetting systems are tested extensively by our quality management team before leaving our factory in Nürtingen, Germany. In addition, numerous standard safety features make them extra safe.

Ultimate flexibility

Regardless of the sector you work in, our comprehensive portfolio of products and accessories ensures that you always have the perfect DYNAJET at your side for every application.

Absolute resilience

Robust and compact, DYNAJET water-jetting systems have been developed for professional use under the most difficult conditions. So you profit from maximum reliability and a long product service life.

← *Water-jetting systems in production at our Nürtingen location*



Always one step ahead

Maximum efficiency, flexibility and economy – with its innovations, DYNAJET lastingly delivers on this brand promise. The engineers in our development department perfect the characteristics and ergonomics of our water-jetting units on an ongoing basis, setting standards for the future with DYNAJET innovations.

DYNAJET innovations ensure optimum performance, reduced fuel consumption, great ease of operation, fewer emissions and more safety. The foundation for all this is our continuous investment in research and development with which we drive our innovations. As a member of the VDMA (Verband Deutscher Maschinen- und Anlagenbau e.V. – German Engineering Federation), DYNAJET also makes a substantial contribution to numerous pre-competitive research and innovation projects in order to establish new products and technologies for water-jetting.

In this way, you can be sure that your investment in DYNAJET's innovative products will pay off in the form of an appreciable increase in productivity in the future, too.



1

Perfect ergonomics for more safety: the DYNAJET high-pressure lance and gun system as of 800 bar (11,600 PSI)

DYNAJET's innovative lance and gun system strictly minimises turbulence losses through optimised hydraulic routing (1). In addition, the central force application (2) in the handle ensures fatigue-free operation without transverse

forces, and therefore increased safety. Twist reduction (3) makes it possible to rotate the nozzle pipe steplessly by 360° to the handgrip. The gun also offers a hand-operated safety trigger.

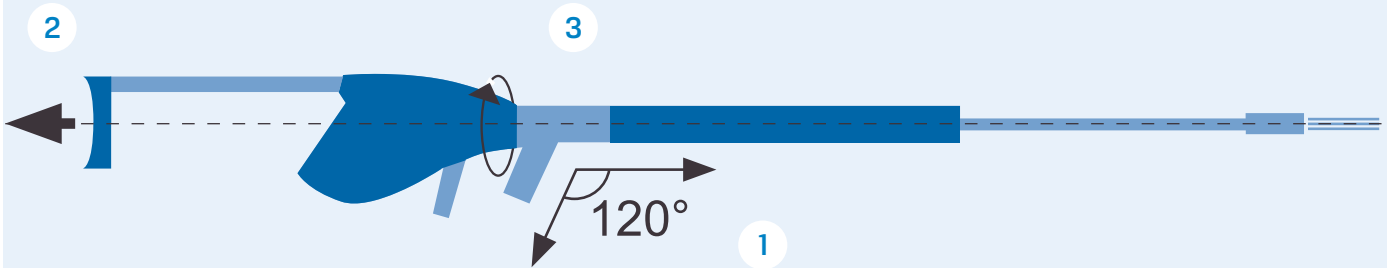

2

Turbo-cleaning: the DYNAJET hot-water principle

Simply switch your DYNAJET to turbo and clean up to 4 times faster: with DYNAJET's unique hot-water principle, you can heat the high-pressure water of DYNAJET machines up to 800 bar (11,600 PSI) as well.

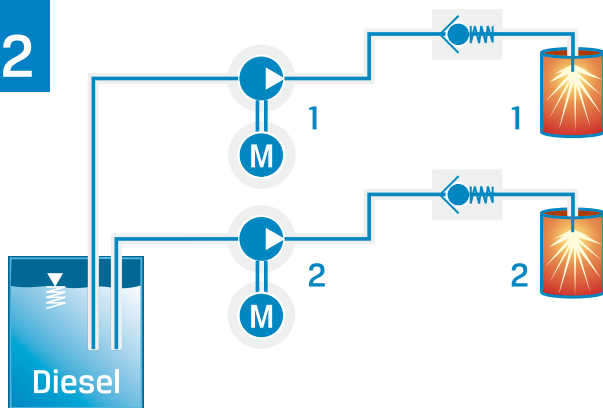

3

Flying high with the DYNAJET HELI valve

With the depressurising DYNAJET HELI valve, you can clean surfaces at a height of up to 75 metres above the machine with the pressureless switching DYNAJET HELI valve. The gentle rise in pressure also makes for a slower increase in reaction force and thus for improved safety and ergonomics.

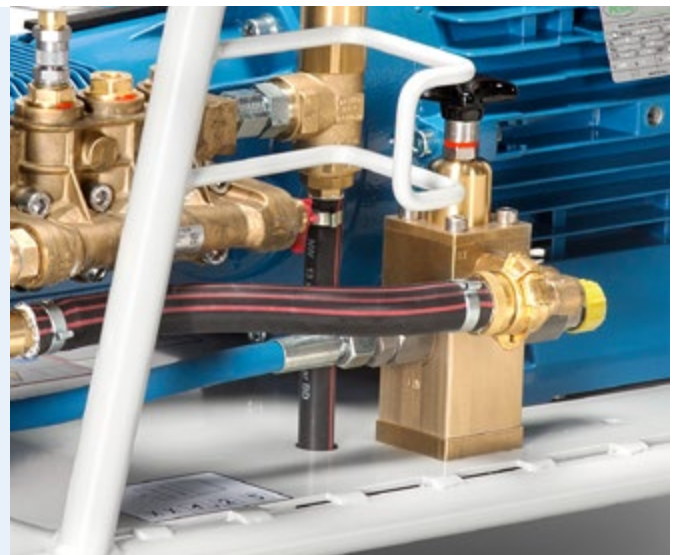

4



More safety and saving of resources: dry-shut guns up to 1,000 bar (14,500 PSI)

Simplify your work and save water as well with DYNAJET's dry-shut guns. At a working pressure of up to 1,000 bar (14,500 PSI), the gun is closed instantly as soon as the water jet is interrupted when you let go of the trigger.

5



Ready for action instantly with the DYNAJET EC Easy Connect rapid connection system

The DYNAJET EC Easy Connect rapid connection system for water-jetting systems up to 3,000 bar (43,500 PSI) not only enables simple, quick and safe connection, but also makes for less wear and tear, as no threaded unions are necessary and so there is no fretting of the threaded parts.

6

Safer and easier access with DYNAJET's TARGA system

The TARGA system of DYNAJET trailers guarantees fast and separate access to the operating and engine areas at all times. The hoods and doors can be opened upwards easily, allowing convenient and safe access to all key components.



Competent service throughout the world and always close by

Maximum service, absolute reliability. With our extensive network of certified DYNAJET sales and service partners, we ensure that you can obtain all our high-pressure cleaners, accessories and original spare parts from nearby at all times throughout the world.

Whether it's a new DYNAJET water-jetting system or a maintenance or repair service that you require, you get the ideal offer and professional support from our experts as soon as possible. What is more, our service partners and dealers also guarantee you the best post-purchase support for the entire service life of your DYNAJET high-pressure cleaner.

So you profit from safe, smooth and efficient operation of your machine at all times, regardless of your location.

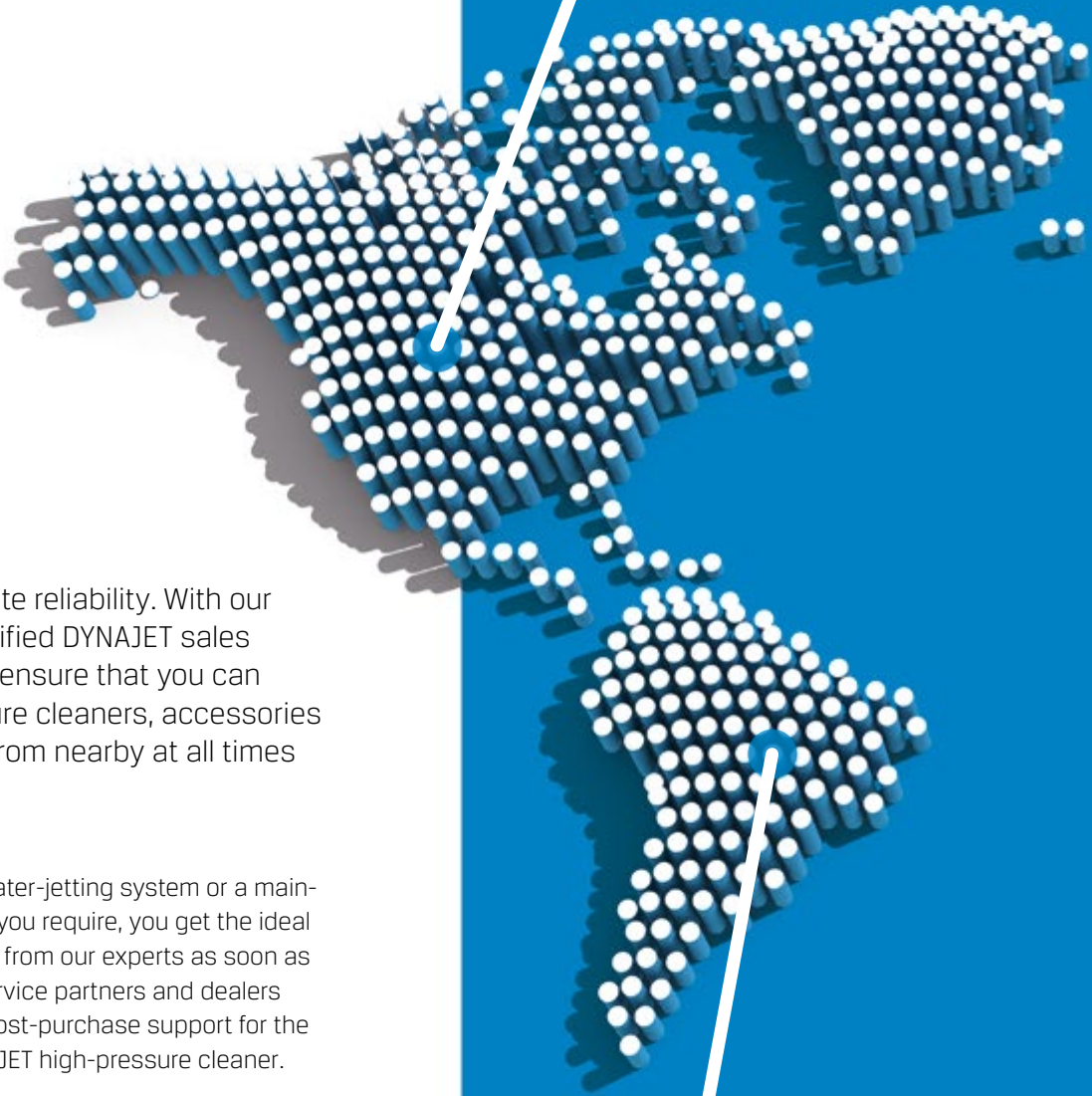

North America
5 sales and service partners

South America
20 sales and service partners

Europe

120 sales and service partners

DYNAJET Headquarters

Nürtingen, DE

DYNAJET France

Colmar, FR

DYNAJET Denmark

Odense, DK

Asia

55 sales and service partners



Africa

15 sales and service partners



With our dealer search, you can find a suitable DYNAJET sales and service partner near you in a jiffy:

→ www.dyna-jet.com/dealers

DYNAJET for construction and renovation



In construction and renovation work particularly, it's speed, efficiency and safety that count. With DYNAJET's professional water-jetting systems, you meet these demands at all times and are ideally equipped for all the construction and renovation challenges you face. Our comprehensive portfolio of products and accessories makes sure of this, offering a

suitable tool for every task. DYNAJET's high-performance water-jetting systems enable you to clean construction equipment, scaffolding and shuttering quickly, thoroughly and economically or restore facades and concrete safely, precisely and inexpensively.



Renovating a facade



Cleaning shuttering

Typical construction and renovation applications

Application	Advantages of DYNAJET	Suitable water-jetting systems
Cleaning construction machinery and installations	<ul style="list-style-type: none"> Fast and thorough cleaning Short set-up times 	350me (pg. 24), 350mg (pg. 24), 350md (pg. 25)
Cleaning shuttering and scaffolding	<ul style="list-style-type: none"> Fast cleaning, directly on site Damage-free cleaning of powder-coated and galvanised shuttering 	350mg (pg. 24), 350md (pg. 25), 500me (pg. 44), 1000me (pg. 62)
Facade renovation	<ul style="list-style-type: none"> Surface preparation 6 times faster Precise removal of individual paint layers 	350mg (pg. 24), 350md (pg. 25), 350th (pg. 27)
Roof cleaning	<ul style="list-style-type: none"> Fast and environmentally friendly solution Unnecessary to climb completely up on to roofs 	350mg (pg. 24), 350md (pg. 25), 350th (pg. 27), 500th (pg. 47)
Concrete restoration and removal	<ul style="list-style-type: none"> Concrete removal & derusting of reinforcements in one step Vibration-free concrete removal without damage to reinforcements or the underlying surface 	UHP 220 (pg. 81)
Motorway renovation	<ul style="list-style-type: none"> Outstanding cleaning and removal results Vibration-free removal 	500th (pg. 47), 800th (pg. 65), UHP 220 (pg. 81)
Removing filling materials from expansion joints	<ul style="list-style-type: none"> Stepless pressure regulation Low reaction force and high area coverage 	500th (pg. 47), UHP 220 (pg. 81)
Cleaning truck-mounted concrete pumps	<ul style="list-style-type: none"> Triple function: high-pressure cleaning, pipe cleaning and emergency hydraulic unit Short set-up times 	350mg Plus (pg. 25)

← Removing concrete to renovate a bridge

DYNAJET for local authorities

Whether it's removing chewing gum and graffiti or cleaning multi-storey car parks and train stations – the range of tasks faced by local authorities is huge. DYNAJET's powerful water-jetting systems support you and ensure that, even during ongoing operations, you succeed with these chal-

lenges without hassle at any time of year. Our professional high-pressure units combine innovation and reliability, and thus achieve maximum efficiency and economy with the highest level of eco-friendliness.



Cleaning a monument



Removing chewing gum

Typical applications for local authorities

Application	Advantages of DYNAJET	Suitable water-jetting systems
Chewing gum removal	<ul style="list-style-type: none"> Fast and economical cleaning Special nozzles for removing chewing gum 	350mg (pg. 24), 350md (pg. 25), 350th (pg. 27)
Cleaning train stations and multi-storey car parks	<ul style="list-style-type: none"> Targeted and thorough floor cleaning with diverse floor-cleaning accessories Cleaning possible without interrupting normal services 	350mg (pg. 24), 350md (pg. 25), 350th (pg. 27)
Graffiti removal	<ul style="list-style-type: none"> Fast removal of graffiti with use of abrasives Special nozzles for different types of dirt 	350mg (pg. 24), 350md (pg. 25), 350th (pg. 27)
Removal of weeds	<ul style="list-style-type: none"> Fast and thorough weed control Environmentally friendly, without the use of chemicals 	350mg (pg. 24), Dynabox 350 (pg. 25), 350th (pg. 27), 500th (pg. 47)
Cleaning pipes	<ul style="list-style-type: none"> Ideal special tool and accessories available Variable pressure ranges 	350mg (pg. 24), 350md (pg. 25), 350th (pg. 27)



Removing graffiti

DYNAJET for industry

With its multifunctional, powerful and economical water-jetting systems, DYNAJET has always been a strong and reliable partner for industry. Production installations of all sizes are cleaned quickly, efficiently and safely with DYNAJET.

Thanks to our multifaceted portfolio of accessories, countless cleaning and renovation tasks can be solved with just one DYNAJET high-pressure cleaner.



Preparing installations for paint removal



Cleaning an industrial floor

Industrial applications with DYNAJET

Application	Advantages of DYNAJET	Suitable water-jetting systems
Paint removal	<ul style="list-style-type: none"> Fast and thorough paint removal with up to 2,800 bar (40,600 PSI) No chemicals necessary 	350mg (pg. 24), 1000me (pg. 62), UHP 220 (pg. 81)
Cleaning installations and components	<ul style="list-style-type: none"> Cleaning appropriate to needs and the respective material Optional hot water 	350mg (pg. 24), 350md (pg. 25), 350th (pg. 27)
Cleaning tanks, drums and containers	<ul style="list-style-type: none"> 'Just-in-time' cleaning Efficient removal of all types of residue 	500th (pg. 47), 800th (pg. 65)
Cleaning heat exchangers	<ul style="list-style-type: none"> Economical and efficient removal of salt and graphite residue and charred deposits Hot water for bituminous deposits 	500th (pg. 47), 800th (pg. 65), 1000me (pg. 62), UHP 220 (pg. 81)



Cleaning heat exchangers

DYNAJET for shipyards and offshore



Whether it's in dry dock, the harbour or on the high seas: DYNAJET is the number one when it comes to efficient cleaning or renovating of ships, dock installations, containers or warehouses.

Removing rust, stripping paint and varnish, removing algae growths or barnacles – DYNAJET cleans everything quickly, thoroughly and reliably. You save time, your nerves and lots of money!



Cleaning a ship



Cleaning containers

Typical shipyard and offshore applications

Application	Advantages of DYNAJET	Suitable water-jetting systems
Cleaning tanks, drums and containers	<ul style="list-style-type: none"> 'Just-in-time' cleaning Efficient removal of all types of residue 	350mg (pg. 24), 350md (pg. 25), 350th (pg. 27), 500me (pg. 44), 500mg (pg. 45), 500th (pg. 47), 800th (pg. 65), UHP 220 (pg. 81)
Cleaning oil-drilling installations	<ul style="list-style-type: none"> Efficient and economical cleaning Removal of bituminous deposits and crude oil residue with hot water 	500th (pg. 47), 800th (pg. 65), UHP 220 (pg. 81)
Cleaning pipelines	<ul style="list-style-type: none"> Special nozzles for different types of dirt and requirements Hot water makes for higher efficiency 	500th (pg. 47)
Cleaning dock installations	<ul style="list-style-type: none"> Removal of even the most stubborn dirt Short set-up times 	500me (pg. 44), 500mg (pg. 45), 500md (pg. 45), UHP 220 (pg. 81)
Cleaning ships	<ul style="list-style-type: none"> Efficient removal of maritime deposits and corrosion Optimum surface preparation 	DYNAJET Seamaid (pg. 45), 500me (pg. 44), 1000me (pg. 62), UHP 220 (pg. 81)

DYNAJET for agriculture and forestry

Agriculture and forestry require professional tools and machines for use in robust conditions. Water-jetting systems and accessories from DYNAJET have been developed for the most difficult conditions and are suitable for numerous applications in agriculture and forestry.

Earth, loess soil and loam are no problem for DYNAJET's powerful high-pressure cleaners, nor is rapid removal of bark from trees. See for yourself and profit from the economy, efficiency and sustainability offered by DYNAJET devices.



Removing bark from trees



Cleaning agricultural and construction machinery

Typical agriculture and forestry applications

Application	Advantages of DYNAJET	Suitable water-jetting systems
Cleaning agricultural and forestry machinery	<ul style="list-style-type: none"> ▪ Cleaning appropriate to needs and the respective material ▪ Optional hot water 	350me (pg. 24), 350mg (pg. 24), 350md (pg. 25), Dynabox 350 (pg. 25)
Surface preparation of bunker silos	<ul style="list-style-type: none"> ▪ Precise removal of coatings ▪ Optimum surface preparation with good tensile strength 	350mg (pg. 24), 350md (pg. 25), Dynabox 350 (pg. 25), 500th (pg. 47), 800th (pg. 65), UHP 220 (pg. 81)
Removing bark from trees	<ul style="list-style-type: none"> ▪ Rapid bark removal that preserves the tree's natural protective layer ▪ Ecological processing of the wood possible 	350me (pg. 24), 350mg (pg. 24), 350md (pg. 25)
Cleaning byres and stables	<ul style="list-style-type: none"> ▪ Fast and thorough cleaning ▪ Short set-up times 	350me (pg. 24), 350mg (pg. 24), 350md (pg. 25)



Restoring a bunker silo

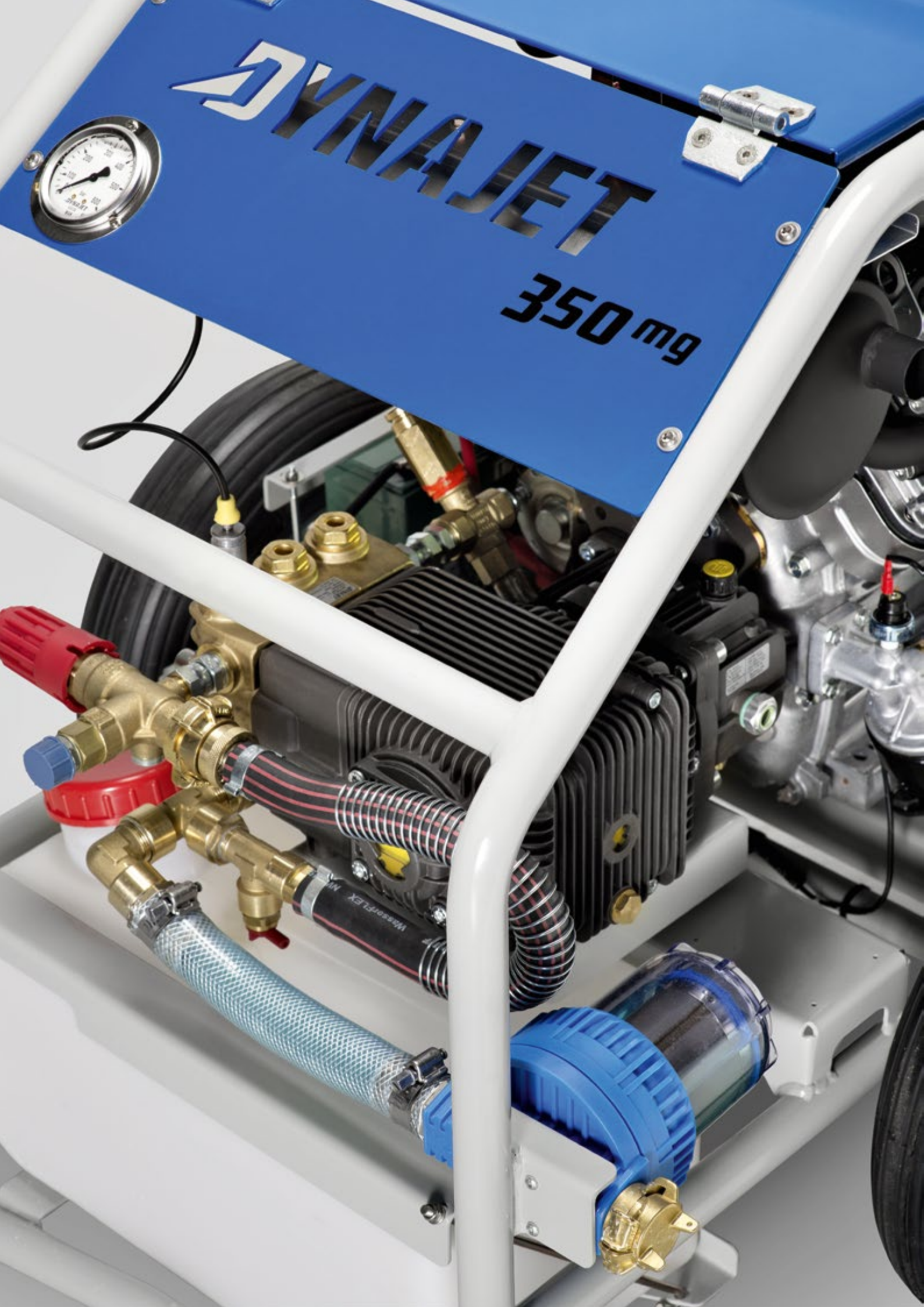

DYNAJET

350 mg

Water-jetting systems and accessories up to 350 bar (5,075 PSI)

Water-jetting systems up to 350 bar

In the pressure class up to 350 bar (5,075 PSI), DYNAJET offers a comprehensive portfolio of high-performance water-jetting systems. On the one hand, we offer a wide selection of mobile and robust trolleys powered by diesel,

petrol or electricity which, with the aid of the Dynabox 350 hot-water generator, can also be used as hot-water systems. On the other, the DYNAJET 350th cold- and hot-water trailer makes for flexible professional deployment options.

Highlights of the 350 bar water-jetting systems



Superior workmanship: designed for difficult working conditions



Simple and safe operation: intuitive control, manual pressure adjustment, safety valves and emergency shutdown switch



A high level of mobility: lifting eyes for easy transportation on construction sites



The ideal complement: thanks to the Dynabox, all trolleys up to 500 bar (7,250 PSI) can be converted into hot-water high-pressure cleaners.

← DYNAJET 350mg: small, efficient and independent – the DYNAJET compact 'mg' class with powerful petrol motor

Trolleys up to 350 bar

Compact, powerful and – down to the very last detail – sophisticated: DYNAJET trolleys with a working pressure of up to 350 bar (5,075 PSI) are simple to manoeuvre, easy to transport and can be deployed flexibly for count-

less applications. Thanks to their ease of operation and the highest safety standards, DYNAJET trolleys simplify everyday working life enormously.

Standard accessories included with all DYNAJET trolleys up to 350 bar:

- 10 m high-pressure hose for hot and cold water
- High-pressure gun with spray lance
- Nozzle carrier and 15° flat-jet nozzle

DYNAJET offers water-jetting systems powered by diesel, petrol or electricity, depending on where they are to be used. For electric motors, there are also numerous special voltages and frequencies available (see machine list on pg. 94).



350me

350mg

Type	Cold-water high-pressure cleaner	Cold-water high-pressure cleaner
Working pressure	Stepless up to 350 bar (5,075 PSI)	Stepless up to 350 bar (5,075 PSI)
Flow rate	Up to 21 l/min (5.56 USgal/min)	Up to 21 l/min (5.56 USgal/min)
Pump	Triplex plunger pump; ceramic-coated plungers	Triplex plunger pump; ceramic-coated plungers
Motor	Electric motor 400 V, 50 Hz, IP54 / 32 A CEE	2-cylinder, 4-stroke petrol motor
Motor output	15 kW (20.1 HP)	16.4 kW (22 HP)
Speed of motor & pump / Drive	1,450/1,450 rpm / Direct	3,250/1,450 rpm / Gearbox
Fuel consumption		Approx. 5.5 l/h (1.46 USgal/h)
Volume of fuel tank		20 l (5.28 USgal)
Discharge coupling (water)	M22 x 1.5 ET	M22 x 1.5 ET
Heat output of oil burner		
Unladen weight	147 kg	105 kg
Dimensions (L x W x H)	110 x 66 x 65 cm	75 x 79 x 99 cm
Article number	1 488 003	1 486 005

Special model: DYNAJET 350mg Plus

The DYNAJET 350mg Plus has been specifically developed for truck-mounted concrete pump operators: it cleans concrete pumps effectively and frees pipelines from concrete completely. What is more, the 350mg Plus serves as an emergency unit if the hydraulic pump happens to fail.



For more detailed information about DYNAJET 350 bar (5,075 PSI) water-jetting systems, please visit:

→ www.dyna-jet.com/350bar

All DYNAJET water-jetting system models and versions are listed as of pg. 94.

**350mg Plus**

Cold-water high-pressure cleaner and hydraulic power pack

Stepless up to 320 bar (4,640 PSI)

Up to 21 l/min (5.56 USgal/min)

Triplex plunger pump; ceramic-coated plungers

2-cylinder, 4-stroke petrol motor

16.4 kW (22 HP)

3,250/1,450 rpm / Gearbox

Approx. 5.5 l/h (1.46 USgal/h)

20 l (5.28 USgal)

M22 x 1.5 ET

67 kW (94 HP)

110 kg

75 x 79 x 99 cm

1 486 089

**350md**

Cold-water high-pressure cleaner

Stepless up to 350 bar (5,075 PSI)

Up to 21 l/min (5.56 USgal/min)

Triplex plunger pump; ceramic-coated plungers

2-cylinder Hatz diesel motor, air-cooled

17 kW (22.8 HP)

2,900/1,450 rpm / Fan belt

Approx. 4.0 l/h (1.06 USgal/h)

20 l (5.28 USgal)

M22 x 1.5 ET

215 kg

91 x 80 x 96 cm

1 513 010

**Dynabox 350** 12 V DC or 1x 230 V / 50 Hz

Hot-water generator

Up to max. 350 bar (5,075 PSI)

12 V DC or 230 V / 50 Hz

Approx. 7.5 l/h (1.98 USgal/h) heating oil

18 l (4.76 USgal)

M22 x 1.5 ET

67 kW (94 HP)

129 kg

80 x 75 x 90 cm

1 492 060 or 1 492 002

Trailers & installation modules up to 350 bar



The all-purpose cold- and hot-water DYNJET 350th high-pressure cleaner as a single-axle trailer: easy to manoeuvre, light in weight, compact and powerful. Thanks to the ideal interplay of water pressure, water volume and water temperature, the 350 bar (5,075 PSI) trailer achieves optimum cleaning results.

Advantages:

- An independent hot-water high-pressure cleaner for flexible deployment at any location.
- Ready for operation immediately thanks to water tank and fixed hose drum.
- Stepless pressure adjustment enables cleaning performance to be optimally adapted to every object.

Standard accessories

High-pressure gun with spray lance (overall length: approx. 800 mm), nozzle carrier, 15° flat-jet nozzle, storage box and document case.

Standard features

Operating-hours counter, hand-throttle control, lifting eye, 12V power socket in the control box, 50 m high-pressure hose and 25 m supply hose mounted on hose drums, 300 l (79.36 USgal) water tank with indicator and monitor, hot-water system, safety valve and pressure-regulation valve.

Optional features

- **DYNAJET HELI valve:** An innovative valve for comfortable working at a height of up to 75 m above the machine.
- **DYNAJET radio remote control:** Control of key functions within a radius of up to 350 m.
- **Vario Control:** Electronic speed regulation via control box and reduction of idle speed.
- **Water-softening system:** Reduces maintenance and protects the burner.
- **Safety package for chemical installations and refineries:** Spark arrestors for motor and burners, connection for external emergency shutdown switch and battery disconnecting switch.
- **External emergency shutdown switch:** With cable drum and 50 m cable.
- **Electric hose drum:** For time savings and convenience.





350th

Type	Hot- and cold-water high-pressure cleaner
Working pressure	Stepless up to 350 bar (5,075 PSI)
Flow rate	7-16 l/min (1.85-4.23 USgal/min)
Pump	Triples plunger pump; ceramic-coated plungers
Motor	Kubota 3-cylinder diesel
Motor output	13 kW (18 HP)
Speed of motor & pump / Drive	3,000/1,090 rpm / Fan belt
Fuel consumption	Approx. 3.9 l/h (1.03 USgal/h)
Volume of fuel tank	70 l (18.52 USgal)
Volume of water tank	300 l (79.36 USgal)
Discharge coupling (water)	M22 x 1.5
Heat output of oil burner	Max. 1 x 115 kW (159 HP) / approx. 95 °C
Consumption of oil burner	Approx. 7 l/h (1.85 USgal/h)
Chassis	Single-axle trailer with brake
Unladen weight	760 kg
Dimensions (L x W x H)	291 x 172 x 177 cm
Dimensions when open (L x W x H)	320 x 172 x 220 cm
Article number	1 480 010
Stationary version	DYNAJET 350sh, article number 1 480 030

DYNAJET ***mdh***

***Kompakt,
leistungsstark und vielseitig***

***Compact,
powerful and versatile***

***Compact,
puissant et polyvalent***



DYNAJET

Water Jetting Systems up to 3,000 bar



Abbildung zeigt DYNAJET 220mdh expert
 Picture shows DYNAJET 220mdh expert
 L'image représente le DYNAJET 220mdh expert

DE	EN	FR
1 Brenner mit patentierter Steuerung ohne Magnetventile	Patented burner control without solenoid valves	Brûleur avec commande breveté sans soupapes magnétique
2 Spritzwasserresistenter Schaltschrank	Splash-resistant electricals box	Armoire électrique résistante aux projections d'eau
3 Hochdruck-Manometer	High-pressure gauge	Manomètre à haute pression
4 Stufenlose Druckverstellung über Handgassteuerung	Stepless pressure control via hand throttle	Ajustement progressif de la pression par la commande manuelle de l'accélérateur
5 Hochdruck-Wasseranschluss	High-pressure water outlet	Raccordement de l'eau à haute pression
6 Anzeigen zur Systemkontrolle	Indicator lights for system surveillance	Voyants pour le contrôle du système
7 Befestigungspunkte	Mounting points	Point de fixation
8 Großer 70 l Dieseltank	Large 70 l diesel tank	Grand réservoir de diesel de 70 l
9 Robuster, pulverbeschichteter Stahlrahmen	Robust, powder-coated steel frame	Châssis d'acier robuste, revêtu par poudre
10 Sicherheitsventil	Safety valve	Soupape de sécurité
11 Betriebsstundenzähler	Operating hours counter	Compteur d'heures d'exploitation
12 Leistungsstarker Dieselmotor	Powerful Diesel engine	Moteur diesel puissant
13 Langsam laufende 3-Plunger Pumpe	Low speed 3-plunger pump	Pompe à rotation lente à 3 pistons
14 Zwei Kranösen	Two crane eyes	Deux œillets pour faciliter le transport

220mdh**350mdh**

Typ Type	Heiß- und Kaltwasser-Hochdruckreiniger Hot and cold water high-pressure cleaner	Heiß- und Kaltwasser-Hochdruckreiniger Hot and cold water high-pressure cleaner
Type	Nettoyeur haute pression à eau froide et chaude	Nettoyeur haute pression à eau froide et chaude
Modell Model Modèle	220mdh	350mdh
Arbeitsdruck Working pressure Pression de service	Stufenlos bis 220 bar Stepless up to 220 bar Réglable en continu jusqu'à 220 bar	Stufenlos bis 350 bar Stepless up to 350 bar Réglable en continu jusqu'à 350 bar
Maximale Fördermenge Maximum flow rate Débit maximal	26 l/min (6.89 USgal/min)	16 l/min (4.23 USgal/min)
Pumpe Pump Pompe	3-Plunger, Vollkeramik Ceramic triplex plunger 3 pistons, céramique	3-Plunger, Vollkeramik Ceramic triplex plunger 3 pistons, céramique
Motor Motor Moteur	Kubota 3-Zylinder Diesel Kubota 3-cylinder diesel motor Moteur diesel tricylindre Kubota	Kubota 3-Zylinder Diesel Kubota 3-cylinder diesel motor Moteur diesel tricylindre Kubota
Motorleistung Motor output Puissance du moteur	13 kW (18 Hp)	13 kW (18 Hp)
Drehzahl Motor & Pumpe / Antrieb Speed of motor & pump / drive Régime moteur et pompe / entraînement	3000 & 1760 UpM / Keilriemen 3000 & 1760 rpm / Fan belt 3000 & 1760 tr/min / courroie trapézoïdale	3000 & 1760 UpM / Keilriemen 3000 & 1760 rpm / Fan belt 3000 & 1760 tr/min / courroie trapézoïdale
Kraftstoffverbrauch Fuel consumption Consommation de carburant	Ø 3,9 l/h (1.03 USgal/h)	Ø 3,9 l/h (1.03 USgal/h)
Volumen Kraftstofftank Volume of fuel tank Capacité du réservoir de carburant	ca. 70 l approx. 70 l (18.50 USgal) 70 l env.	ca. 70 l approx. 70 l (18.50 USgal) 70 l env.
Druckabgang (Wasser) Discharge coupling (water) Sortie de pression (eau)	M22 x 1,5 AG M22 x 1,5 IT M22 x 1,5 FI	M22 x 1,5 AG M22 x 1,5 IT M22 x 1,5 FI
Heizleistung Ölbrenner Heat output of oil burners Puissance de chauffe du brûleur fioul	max. 115 kW (ca. 95° C) max. 115 kW (159 Hp) 115 kW max.	max. 115 kW (ca. 95° C) max. 115 kW (159 Hp) 115 kW max.
Verbrauch Ölbrenner Consumption of oil burners Consommation du brûleur à fioul	ca. 7 l/h approx. 7 l/h (1.85 USgal/h) env. 7 l/h	ca. 7 l/h approx. 7 l/h (1.85 USgal/h) env. 7 l/h
Leer-Gewicht Unladen weight Poids à vide	ca. 420 kg approx. 420 kg 420 kg env.	ca. 420 kg approx. 420 kg 420 kg env.
Maße (L x B x H) Dimensions (L x W x H) Dimensions (L x l x h)	120 x 80 x 112 cm	120 x 80 x 112 cm

Versionsübersicht**Version summary**

Vue d'ensemble des versions

220mdh	1546712	350mdh	1546710
220mdh HELI	1546722	350mdh HELI	1546720
220mdh HELI + ATC	1546752	350mdh HELI + ATC	1546750
220mdh HELI + ATC + RC	1546792	350mdh HELI + ATC + RC	1546790
220mdh expert	1546770	350mdh expert	1546711
220mdh expert HELI	1546723	350mdh expert HELI	1546721
220mdh expert HELI + ATC	1546753	350mdh expert HELI + ATC	1546751
220mdh expert HELI + ATC + RC	1546793	350mdh expert HELI + ATC + RC	1546791

Weitere Informationen und Zubehör: www.dynajet.de/mdh

More information and accessories: www.dyna-jet.com/mdh

Plus d'information et d'accessoires: www.dynajet-france.fr/mdh



DYNAJET GmbH

Wilhelm-Maybach-Str. 2
72622 Nürtingen
Germany

Tel: +49 7022 30411-30

Fax: +49 7022 30411-50

Web site: www.dynajet.de

Mail: info@dynajet.de

© DYNAJET GmbH, 2018

Misprints and errors excepted.

Subject to changes without notification.

DYNAJET



Water-jetting systems and accessories up to 350 bar (5,075 PSI)

Accessories up to 350 bar

DYNAJET original accessories meet high quality standards and are perfectly attuned to numerous applications. They specifically optimise work efficiency and cleaning depth in line with their area of deployment. In addition to accessory

sets, hoses, lances, guns and nozzles, DYNAJET also offers special accessories for applications such as water-sandblasting, or cleaning floors, roofs, walls, pipes or heat exchangers.



For more detailed information about DYNAJET 350 bar (5,075 PSI) accessories, please visit:
→ www.dyna-jet.com/acc350

Abbreviations used

DN: Diameter (mm)
PN: Max. operating pressure (bar/PSI)

IT: Internal thread
ET: External thread
Art. no.: Article number

Accessory sets

Rotating nozzle system

Set consisting of spray lance, coupling and rotating nozzle.

Water-jetting system	Art. no.
150me	460 043
280me + 350th + 350sh	459 340
350me + 350mg + 350mg Plus + 350md	459 342



WSS 500 water-sandblasting system

Set consisting of spray lance, coupling, spray head incl. nozzle, and suction hose with suction pipe.

Water-jetting system	Art. no.
150me	460 044
280me + 350th + 350sh	459 346
350me + 350mg + 350mg Plus + 350md	459 348



WSS 1000 water-sandblasting system

Set consisting of spray lance, coupling, spray head incl. nozzle set, and suction hose with suction pipe.

Water-jetting system	Art. no.
280me + 350th + 350sh	459 347
350me + 350mg + 350mg Plus + 350md	459 349



← Rotating nozzle (shape F)

Hose lines and accessories

Extension hoses

DN 8 hoses for up to 150° C with connections via rapid-release couplings 2x M22 x 1.5 IT.

Hose lines	Art. no.
Length: 10 m	440 607
Length: 25 m	440 606
Length: 50 m	546 790
O-ring and support ring	
O-ring for rapid-release coupling	471 538
Support ring for rapid-release coupling	434 458



Hose connector

Hose connector	Art. no.
As a double nipple for coupling two high-pressure hoses. Connections: 2x M22 x 1.5 ET.	427 518



Swivel joint

Swivel joint	Art. no.
Deployed directly on the gun inlet between the high-pressure hose and the gun to prevent the hose from twisting. Connections: M22 x 1.5 ET / M22 x 1.5 IT.	446 920



Guns and accessories

350 bar high-pressure gun

With servo valve for minimised trigger force. Safety catch to lock the trigger in place. Fully insulated, with stainless steel internal parts. For hot water up to 150 °C. Overall length: approx. 400 mm. Connections: M22 x 1.5 ET / M22 x 1.5 IT.

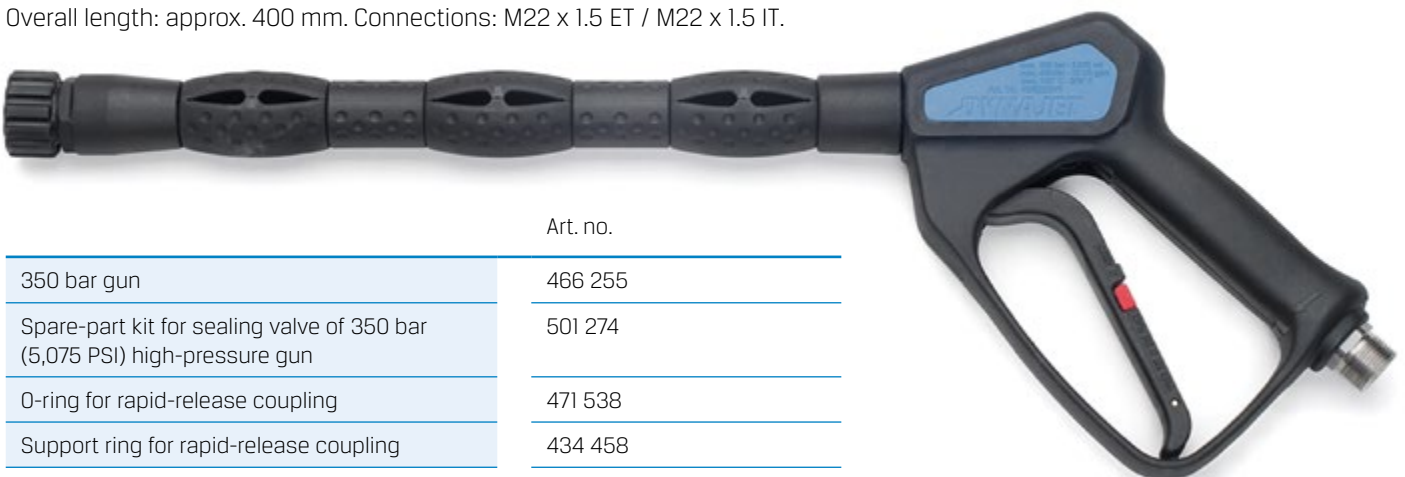

	Art. no.
350 bar gun	466 255
Spare-part kit for sealing valve of 350 bar (5,075 PSI) high-pressure gun	501 274
O-ring for rapid-release coupling	471 538
Support ring for rapid-release coupling	434 458

Handgrip

	Art. no.
Side handgrip for 350 bar (5,075 PSI) high-pressure gun; steplessly adjustable. No tool required for retrofitting.	446 916

**Coupling**

	Art. no.
Between gun and extension lance. Connections: M22 x 1.5 / 1/4" IT. Complete with O-ring.	427 197
Replacement O-ring	436 797

**Extension lances**

	Art. no.
Length: 350 mm; 1/4" ET / 1/4" ET	427 179
Length: 800 mm; 1/4" ET / 1/4" ET	427 584



For safety reasons, a spray lance measuring 350 mm or more must always be chosen so that, in combination with the high-pressure gun and nozzle carrier, an overall length of approx. 800 mm is reached.

Nozzle carriers

	Art. no.
For shape A and B nozzles. Connection: 1/4" IT, directly on to the extension lance.	495 294
For shape C and D plug-in nozzles. Connection: 1/4" IT. Complete with O-ring for direct connection to the extension lance.	431 516
O-ring and support ring	
O-ring for shape C and D plug-in nozzle carrier	484 295
Support ring for shape C and D plug-in nozzles	489 307

**Double-spray lance**

	Art. no.
For direct connection to the high-pressure gun. Pressure can be regulated steplessly with the handgrip via the valve. Length: approx. 650 mm. 2 nozzle carriers for shape A or B nozzles. Equipped with a shape B low-pressure nozzle (506 422). Connection: M22 x 1.5 ET. High-pressure nozzle not included.	427 460
Spare-part kit for valve	505 583

High-pressure nozzles

Round-jet nozzles (shape A)

Water-jetting system	Designation	Art. no.
150me	015	427 333
280me + 350th	0035	414 019
350me + 350mg + 350md	005	427 136



Flat-jet nozzles (shape B)

Water-jetting system	Designation	Art. no.
15° jet angle (standard)		
150me	1515	425 853
280me + 350th	15034	414 016
350me + 350mg + 350md	1505	427 144
40° jet angle		
150me	4015	427 137
280me + 350th	40034	427 138
350me + 350mg + 350md	4005	427 141

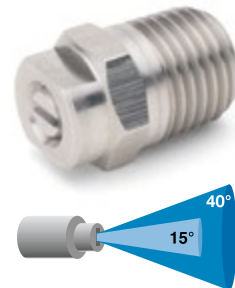

Round-jet nozzles, plug-in type (shape C)

Water-jetting system	Designation	Art. no.
280me + 350th	1.1	438 670
350me + 350mg + 350md	1.3	438 673

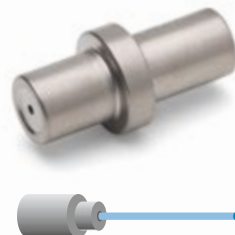

Flat-jet nozzles, plug-in type (shape D)

Water-jetting system	Designation	Art. no.
15° jet angle (standard)		
280me + 350th	1.3	498 402
350me + 350mg + 350md	1.6	436 922
30° jet angle		
280me + 350th	1.3	447 887
350me + 350mg + 350md	1.6	438 679

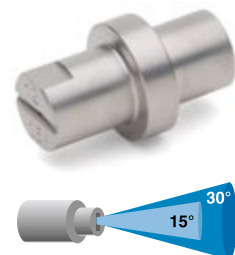

Rotating nozzles (shape F)

With special, heat-resistant ceramic for rotor and seat, deployable up to 150 °C. Anti-impact protective plastic cover. Connection: 1/4" IT.

Water-jetting system	Designation	Art. no.
150me	150	414 024
280me + 350th	035	414 023
350me + 350mg + 350md	050	427 498



Please note: Always start rotor nozzles downwards! Otherwise damage may be caused to the rotor.

Rotating nozzles with manual speed adjustment (shape F)

Enable the strength of the jet to be adapted for sensitive or varying surfaces. Deployable up to 150 °C. Connection: 1/4" IT.

Water-jetting system	Designation	Art. no.
280me + 350th	035	414 025
350me + 350mg + 350md	050	427 589



Repair kits

For shape F rotating nozzles. Contain replacement nozzles and ceramic seat. Specifically designed for the high water temperatures of DYNAJET water-jetting systems.

Nozzle type	Designation	Art. no.
Nozzle 414 024	150	414 028
Nozzle 414 023	035	414 027
Nozzle 427 498	050	427 499
With speed adjustment		
Nozzle 414 025	035	414 029
Nozzle 427 589	050	431 485



Poly nozzles

Multi-jet nozzles, ideal for removing chewing gum. Brass housing with integrated metal filter. Deployable up to max. 90 °C. Connection: 1/4" IT.

Water-jetting system	Designation	Art. no.
280me + 350th	035	461 181
350me + 350mg + 350md	050	461 182



Water-sandblasting systems and accessories

WSS 500 water-sandblasting system

Sandblasting head with boron carbide focus nozzle. Lateral sand feed. Accommodates shape B nozzles. 15° jet angle. Connection: 1/4" IT.

	Art. no.
WSS 500 (shape B nozzle not included)	418 177
Replacement boron carbide focus nozzle	430 185



High-pressure nozzles (shape B) for WSS 500 sandblasting head

Water-jetting system	Designation	Art. no.
150me	1515	425 853
280me + 350th	15034	414 016
350me + 350mg + 350md	1505	427 144

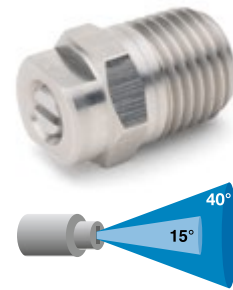

Blasting-abrasive suction pipe for WSS 500

	Art. no.
Offering stepless quantity adjustment of the blasting medium	414 036

WSS 1000 water-sandblasting system

Professional sandblasting head for continuous deployment. Circular arrangement of the high-pressure nozzles. Central sand feed. Tungsten carbide focus nozzle. Connection: 9/16" - 18 UNF IT. Accommodates 3 high-pressure nozzles (shape E).

	Art. no.
WSS 1000 (shape E nozzle inserts not included)	435 111
Replacement tungsten carbide focus nozzle for WSS 1000	450 815



Adapter nipple for WSS 1000

	Art. no.
Connects the WSS 1000 to spray lances with 1/4" ET, inlet: 1/4" IT, outlet: 9/16" - UNF ET	448 204



Nozzle sets (shape E) for WSS 1000 water-sandblasting system

High-pressure nozzle sets for WSS 1000 sandblasting head.

Each set consists of 3 nozzles

Water-jetting system	Designation	Art. no.
280me + 350th	0.6	447 560
350me + 350mg + 350md	0.7	447 561

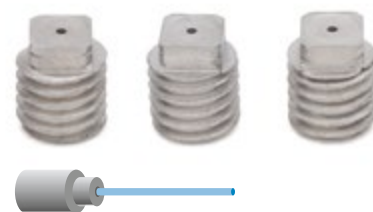

Special tool

	Art. no.
For replacing shape E nozzles for WSS 1000	438 684



Blasting-abrasive suction pipe for WSS 1000

	Art. no.
Offering stepless quantity adjustment of the blasting medium	435 113

Blasting-abrasive suction hose for WSS 500 and WSS 1000

	Art. no.
With spiral inlay; length: approx. 12 m	414 037
Clamp for blasting-abrasive suction hose. 2 required (1 on the blasting head and 1 on the suction pipe)	001 422



Floor-cleaning system and accessories

DYNAJET DFS 350 floor-cleaning system

With 350 bar (5,075 PSI), perfect for effective cleaning of surfaces such as floors, roads or cycle paths. Fully equipped with high-pressure gun. Hose connection: M22 x 1.5 ET. Nozzles, O-ring and support ring not included.

- **Efficient and powerful:** Uses hot water up to 120 °C. Nozzle carriers to accommodate two shape D high-performance nozzles for maximum results.
- **Mobile and robust:** Four steerable, heat- and oil-resistant wheels for extra-smooth motion without jamming. Flexible positioning of hot-water high-pressure hose. Folding handle for easy transportation and space-saving storage.
- **Superior and practical:** In stainless steel with welded stainless steel nozzle rotor. Splash guard to prevent the surrounding area from becoming dirty.



	Data	Art. no.
Working pressure	Up to 350 bar	494 302
Flow rate	Max. 45 l/min	
Temperature	Max. 120° C	
Diameter	520 mm	
Wheels	60 mm	
Connection	M22 x 1.5 ET	
Nozzles	2x shape D	
Replacement high-pressure swivel		501 578
Replacement gun		444 084
Union nut for nozzle		525 047

Nozzles (shape D) for DFS 350

Two identical nozzles are required for the DFS 350.

Water-jetting system	Designation	Art. no.
15° jet angle		
280me + 350th	0.95	498 406
350me + 350mg + 350md	1.10	498 401
30° jet angle (DYNAJET recommendation)		
280me + 350th	0.95	498 393
350me + 350mg + 350md	1.10	498 394
O-ring and support ring		
O-ring for shape C and D plug-in nozzle carrier		484 295
Support ring for shape C and D plug-in nozzles		489 307

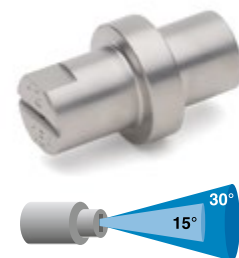

Roof cleaning

DYNAJET DRS-W roof-cleaning system

Suitable for corrugated roofs. Fully equipped with brush, manometer, 2/2-way ball valve for high-pressure on/off, wheels (distance adjustable), and nozzle bar for 2 identical shape D nozzles. Connection: M22 x 1.5 ET. 400 mm in diameter. Nozzles, O-ring and support ring not included.



Art. no.

DRS-W	426 846
Replacement high-pressure swivel	418 362

DYNAJET DRS roof-cleaning system

Ideal for cleaning concrete-tile und clay-tile roofs. Fully equipped with brush, manometer, 2/2-way ball valve for high-pressure on/off, wheels (distance and height adjustable to roof profile), and nozzle bar for 2 identical shape D nozzles. Connection: M22 x 1.5 ET. 500 mm in diameter. Nozzles, O-ring and support ring not included.



Art. no.

DRS	546 817
Replacement high-pressure swivel	546 587

Nozzle selection (shape D) for DRS-W and DRS

Two identical nozzles are required for both the DRS-W and DRS.

Water-jetting system	Designation	Art. no.
15° jet angle		
280me + 350th	0.95	498 406
350me + 350mg + 350md	1.10	498 401
30° jet angle		
280me + 350th	0.95	498 393
350me + 350mg + 350md	1.10	498 394
O-ring and support ring		
O-ring for shape C and D plug-in nozzle carrier		484 295
Support ring for shape C and D plug-in nozzles		489 307

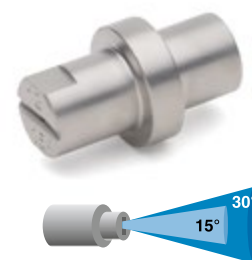

Wall cleaning

DYNAJET DWS 350 wall-cleaning system

Ideal for hand-guided work, cleaning walls, ceilings and small surfaces. Excellent results due to the unvarying distance between the nozzle rotor and object. Hose connection: M22 x 1.5 ET.

Fully equipped with spray-gun handle, stainless steel splash guard with brush and side handgrip, double walls with 2" vacuum connection, and nozzle rotor for accommodating 2 identical shape A or B nozzles. Nozzles not included.



	Art. no.
DWS 350/3D (diameter: 300 mm)	443 314
Replacement high-pressure swivel	443 633
Replacement gun	444 084

Nozzle selection (shape B) for DWS 350

Two identical nozzles are required for the DFS 350.

Water-jetting system	Designation	Art. no.
280me + 350th	1502	414 018
350me + 350mg + 350md	15028	427 823

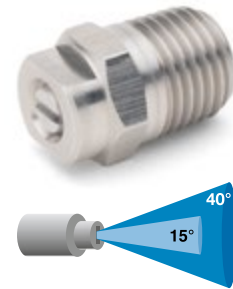

Pipe, drain and heat exchanger cleaning

F 500 foot valve

To switch the high pressure on and off easily when cleaning pipes. Stainless steel casing. Inlet: M22 x 1.5 ET, outlet: M22 x 1.5 IT; max. 60 l/min (15.90 USgal/min).

Connecting nipple to connect foot valve and pipe-cleaning hose. Connections: M22 x 1.5 ET / 1/4" IT.

Art. no.

503 865

427 197



Pipe-cleaning hoses

Suitable for DYNAJET models up to 350 bar (5,075 PSI). Connect directly to the F 500 foot valve with the connecting nipple.

	Art. no.
Length: 15 m; connection: 1/4" ET / 1/4" ET	414 040
Length: 25 m; connection: 1/4" ET / 1/4" ET	414 041
Length: 50 m; connection: 1/4" ET / 1/4" ET	414 042



Pipe-cleaning nozzles

For direct connection to pipe-cleaning hoses.

Standard nozzles

For all areas of application. Drilled as pulling nozzles for autonomous feed.

Water-jetting system	Pipe diameter	Art. no.
150me	> 30 mm	414 046
280me + 350th	> 30 mm	434 659
350me + 350mg + 350md	> 30 mm	414 045



Rotating nozzles

For complete, all-round cleaning. Not available as pulling nozzles.

Water-jetting system	Pipe diameter	Art. no.
280me + 350th	30-100 mm	434 660
350me + 350mg + 350md	30-100 mm	414 049
2x 350me or 2x 350mg or 2x 350md	30-100 mm	459 816



Pocking nozzles

For cleaning completely blocked pipes. Drilled as pulling nozzles.

Water-jetting system	Pipe diameter	Art. no.
150me	> 40 mm	414 048
280me + 350th	> 40 mm	434 661
350me + 350mg + 350md	> 40 mm	414 047



Tank and container cleaning

DYNAJET TWS 200 tank-cleaning system

Rotating high-pressure nozzle head for interior cleaning of tanks, drums, barrels and containers. Stainless steel. Head diameter: 40 mm. Shaft length: 700 mm. Overall length: approx. 1,050 mm. Weight: approx. 25 kg. Inlet: M22 x 1.5 ET. Fully equipped with safety valve on the inlet and 2 high-pressure nozzles. Designed for a working pressure of 200 bar (2,900 PSI) and 21 l/min (5.56 USgal/min). Various drive motors can be selected for the nozzle head:

	Art. no.
Electric motor	446 917
Pneumatic motor	446 918
Water motor, without external energy supply	446 919



DYNAJET TWS 400 tank-cleaning system

For interior cleaning of tanks, drums, barrels and containers. Fully equipped with rotor and 2 shape A nozzles. Designed for 350 bar (5,075 PSI) and 21 l/min (5.56 USgal/min). Connection for hose: M22 x 1.5 ET. Driven by nozzle reaction force without any external drive. Rotor speed can be adapted via the position of the nozzles on the rotor.

	Art. no.
Aluminium housing	459 469
Stainless steel housing	495 800



Other accessories up to 350 bar

Chemical injector

For injection of cleaning agents by vacuum. Connection straight after unloader valve. Inlet: M22 x 1.5 IT, outlet: M22 x 1.5 ET. Adjustable dosage. Complete with plastic hose. Max. 350 bar (5,075 PSI). Only in combination with double-spray lance (art. no. 427 460)

Art. no.

445 582



Couplings / rapid-release couplings

Connection	Picture	Art. no.
M22 x 1.5 ET, 1/4" IT	1	427 197
M22 x 1.5 IT, 1/4" IT	2	427 587
M22 x 1.5 IT, 1/4" ET	3	427 586
M22 x 1.5 IT, 3/8" ET	4	427 585
M22 x 1.5 IT, 3/8" IT	5	427 534
M22 x 1.5 ET, 3/8" IT	6	427 425
M22 x 1.5 ET, 1/4" ET	7	428 016
M22 x 1.5 ET, 3/8" ET	8	428 017
O-ring for rapid-release coupling	(1; 6-8)	436 797
O-ring for rapid-release coupling M22 x 1.5	(2-5)	471 538
Support ring for rapid-release coupling M22 x 1.5	(2-5)	434 458



Hose drum

	Art. no.
Loose drum for flexible installation. Includes hand crank, high-pressure swivel, mounting plate and locking mechanism. Inlet: M22 x 1.5 ET, outlet: 3/8" BSP ET. For max. 75 m high-pressure hose (DN 8).	547 586



Hoses for hose drum

Suitable for hose drum (art. no. 459 309) or 350th trailer. DN 8.
Connections: 3/8" BSP 90° directly on the drum, M22 x 1.5 IT.

	Art no.
Length: 25 m	440 603
Length: 50 m	440 604
Length: 75 m	440 605



Distributor

	Art. no.
For parallel operation of one DYNAJET water-jetting system by two consumers. 1x inlet M22 x 1.5 ET, 2x outlet M22 x 1.5 ET. Can also be used as a collecting component for two pumps to one consumer (only possible with DYNAJET water-jetting systems equipped with an unloader valve without hose-pressure drop-down system).	457 606



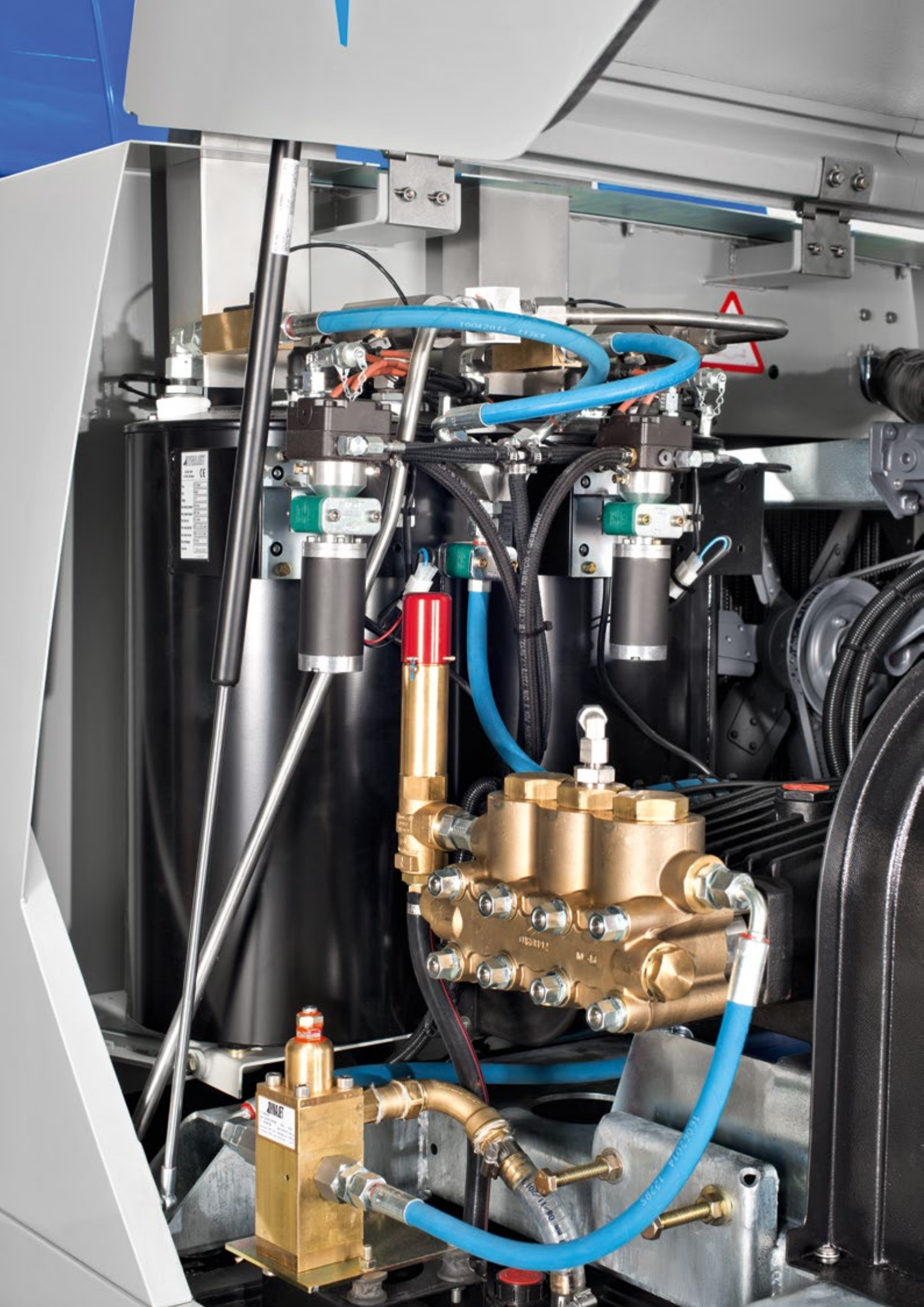

Water-jetting systems and accessories up to 500 bar (7,250 PSI)

Water-jetting systems up to 500 bar

With a working pressure of 500 bar (7,250 PSI) and the right DYNAJET tool, you achieve impressive cleaning results in a very short time. Select the trolley, trailer or stationary water-jetting system suitable for your

applications – with DYNAJET, you always get a powerful, long-lasting and superior-quality machine for professional deployment.

Highlights of the 500 bar water-jetting systems

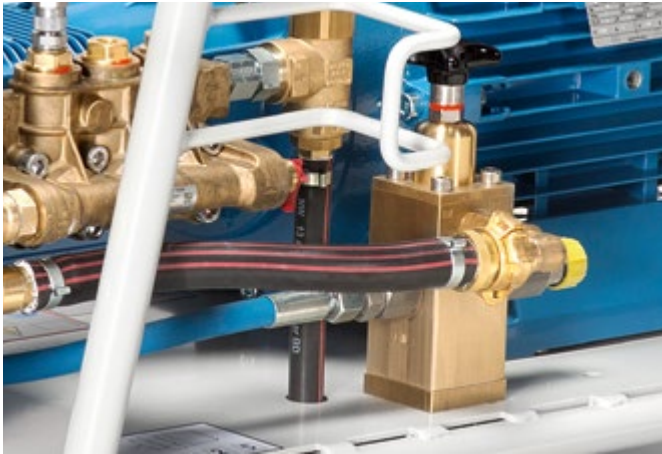

Simple working at height: most of the 500 bar units are equipped with the DYNAJET HELI valve



Safety and comfort: intuitive control, manual pressure adjustment, safety valves and emergency shutdown switch



Optimum mobility and efficiency: easy transportation, short set-up times and fast deployment



Quick upgrading: thanks to the Dynabox, all trolleys up to 500 bar (7,250 PSI) can be converted into hot-water high-pressure cleaners

Trolleys up to 500 bar

DYNAJET trolleys with a working pressure of up to 500 bar (7,250 PSI) offer you the ideal power and efficiency for a huge diversity of cleaning and renovation tasks. This means that you can meet your challenges and carry out your work

processes as fast as possible and without difficulty at all times. You can rely on the sophisticated DYNAJET technology, maximum economy and extra safety.

Standard accessories included with all DYNAJET trolleys up to 500 bar:

- 10 m high-pressure hose for hot and cold water
- High-pressure gun with spray lance
- Nozzle carrier and 15° flat-jet nozzle

DYNAJET offers trolleys powered by diesel, petrol or electricity, depending on where they are to be used. For electric motors, there are also numerous special voltages and frequencies available (see machine list on pg. 94)



500me



500me-30

Type	Cold-water high-pressure cleaner	Cold-water high-pressure cleaner
Working pressure	Stepless up to 500 bar (7,250 PSI)	Stepless up to 500 bar (7,250 PSI)
Flow rate	Up to 15 l/min (3.96 USgal/min)	Up to 30 l/min (7.93 USgal/min)
Pump	Triplex plunger pump; ceramic-coated plungers	Triplex plunger pump; ceramic-coated plungers
Motor	Electric motor 400 V, 50 Hz, IP54 / 32 A CEE	Electric motor 400 V, 50 Hz, IP54 / 63 A CEE
Motor output	15 kW (20.1 HP)	30 kW (41 HP)
Speed of motor & pump / Drive	1,450/1,450 rpm / Direct	1,450/970 rpm / Fan belt
Fuel consumption		
Volume of fuel tank		
Discharge coupling (water)	M24 x 1.5 ET	M24 x 1.5 ET
Heat output of oil burner		
Unladen weight	147 kg	450 kg
Dimensions (L x W x H)	110 x 66 x 65 cm	116 x 80 x 130 cm
Article number	1 509 018	1 518 020

Special model: DYNAJET Seamaid

The DYNAJET Seamaid has been developed for deployment on deep-sea vessels. As a variation of the DYNAJET 500me, the Seamaid has a special stainless steel casing. This means that, despite the adverse conditions on the high seas under which it must operate, the trolley is suitable for applications such as cleaning and preserving decks, tanks, boiler installations, containers and stowage.



For more detailed information about DYNAJET 500 bar (7,250 PSI) water-jetting systems, please visit:
→ www.dyna-jet.com/500bar

All DYNAJET water-jetting system models and versions are listed as of pg. 94.

**500mg**

Cold-water high-pressure cleaner

Up to 500 bar (7,250 PSI)

Up to 15 l/min (3.96 USgal/min)

Triplex plunger pump;
ceramic-coated plungers

2-cylinder,
4-stroke petrol motor

16.4 kW (22 HP)

3,250/1,450 rpm / Gearbox

Approx. 5.5 l/h (1.46 USgal/h)

20 l (5.28 USgal)

M24 x 1.5 ET

128 kg

75 x 79 x 99 cm

1 486 050

**500md**

Cold-water high-pressure cleaner

Up to 500 bar (7,250 PSI)

Up to 15 l/min (3.96 USgal/min)

Triplex plunger pump;
ceramic-coated plungers

2-cylinder
Hatz diesel motor, air-cooled

17 kW (22.8 HP)

2,900/1,450 rpm / Fan belt

Approx. 4.0 l/h (1.06 USgal/h)

20 l (5.28 USgal)

M24 x 1.5 ET

215 kg

91 x 80 x 96 cm

1 513 020

**Dynabox 500** 12 V DC or 1x 230 V / 50 Hz

Hot-water generator

Max. 500 bar (7,250 PSI)

12 V DC or 230 V / 50 Hz

Approx. 7.5 l/h (1.98 USgal/h) heating oil

18 l (4.76 USgal)

M24 x 1.5 ET

67 kW (94 HP)

129 kg

80 x 75 x 90 cm

1 521 009 or 1 521 022

Trailers & installation modules up to 500 bar



In addition to its user-friendliness, it's the light weight, compact dimensions and high level of performance and safety in particular that make the DYNJET 500th all-purpose cold- and hot-water high-pressure cleaner, offering a working pressure of up to 500 bar (7,250 PSI), stand out.

Advantages:

- A powerful hot-water high-pressure cleaner for flexible deployment at any location.
- Ready for operation immediately thanks to water tank and fixed hose drum.
- Stepless pressure adjustment enables cleaning performance to be optimally adapted to every object.

Standard accessories

High-pressure gun with spray lance (overall length: approx. 800 mm), nozzle carrier, 15° flat-jet nozzle, storage box and document case.

Standard features

2x high-performance hot-water generators, DYNJET HELI valve, 12 V socket, 50 m high-pressure hose and 25 m low-pressure supply hose on hose drums, safety valve, automatic pressure regulation with hose-pressure drop-down system, 1,000 l (264.55 USgal) water-storage tank and lifting eye.

Optional features

- **DYNJET radio remote control:** Control of key functions within a radius of up to 350 m.
- **Vario Control:** Electronic speed regulation via control box and reduction of idle speed.
- **Water-softening system:** Reduces maintenance and protects the burner.
- **Safety package for chemical installations and refineries:** Spark arrestors for motor and burners, connection for external emergency shutdown switch and battery disconnecting switch.
- **External emergency shutdown switch:** With cable drum and 50 m cable.
- **Work box package:** Aluminium cover for operating area. Includes stainless steel storage box and vice.





500sh

500th

Type	Hot- and cold-water high-pressure cleaner
Working pressure	Stepless up to 500 bar (7,250 PSI)
Flow rate	15 – 30 l/min (3.96 – 7.93 USgal/min)
Pump	Triplex plunger pump; ceramic-coated plungers
Motor	Deutz 3-cylinder diesel (oil-cooled)
Motor output	34 kW (46.2 HP)
Speed of motor & pump / Drive	2,250/1,000 rpm / Fan belt
Fuel consumption	Approx. 10 l/h (2.65 USgal/h)
Volume of fuel tank	70 l (18.52 USgal) / 105 l (27.78 USgal)
Volume of water tank	1,000 l (264.55 USgal)
Discharge coupling (water)	M24 x 1.5 IT
Heat output of oil burners	2x 91 kW (2x 125 HP)
Consumption of oil burners	Approx. 7 l/h (1.85 USgal/h)
Chassis	Single-axle trailer with brake
Unladen weight	1,660 kg
Dimensions (L x W x H)	371 x 207 x 208 cm
Dimensions when open (L x W x H)	398 x 207 x 277 cm
Article number	1 490 020
Stationary version	500sh, article number 1 490 030



ДУМА

ДУМА

Water-jetting systems and accessories up to 500 bar (7,250 PSI)

Accessories up to 500 bar

DYNAJET original accessories meet high quality standards and are perfectly attuned to numerous applications. They specifically optimise work efficiency and cleaning depth in line with their area of deployment. In addition to accessory

sets, hoses, lances, guns and nozzles, DYNAJET also offers special accessories for applications such as water-sandblasting, or cleaning surfaces, pipes or heat exchangers.



For more detailed information about DYNAJET 500 bar (7,250 PSI) accessories, please visit:
→ www.dyna-jet.com/acc500

Abbreviations used

DN: Diameter (mm)
PN: Max. operating pressure (bar/PSI)
IT: Internal thread
ET: External thread
Art. no.: Article number

Accessory sets

Rotating nozzle system

Set consisting of spray lance, coupling and rotating nozzle.

Water-jetting system	Art. no.
500me + 500mg + 500md	459 345
500me-30 + 500th	459 344



WSS 1000 water-sandblasting system

Set consisting of spray lance, coupling, spray head incl. nozzle set, and suction hose with suction pipe.

Water-jetting system	Art. no.
500me + 500mg + 500md	459 353
500me-30 + 500th	459 351



Hose lines and accessories

Extension hoses

DN 10 hoses for up to 120 °C with connections via rapid-release couplings 2x M24 x 1.5 IT.

Hose lines	Art. no.
Length: 10 m	503 954
Length: 25 m	503 955
Length: 50 m	524 382
O-ring for rapid-release coupling	546 637
Support ring for rapid-release coupling	546 638



Hose connector

Hose connector	Art. no.
For coupling two high-pressure hoses. Connections: 2x M24 x 1.5 ET.	546 804
Replacement O-ring (20 x 2.5)	018 893



Guns and accessories

600 bar high-pressure gun

Stainless steel gun with servo valve for minimised trigger force. Side handgrip that can be secured in various positions. Integrated swivel joint. Fully insulated. For hot water up to 150 °C. Overall length: approx. 630 mm. Max. 60 l/min (15.90 USgal/min). Connections: M24 x 1.5 ET / M24 x 1.5 IT.



	Art. no.
600 bar gun	546 527
Spare-part kit	546 616
O-ring for rapid-release coupling	546 637
Support ring for rapid-release coupling	546 638
Shoulder support. Mandatory for reaction forces greater than 150 newtons.	447 592

Coupling

	Art. no.
Between gun and extension lance. Connections: M24 x 1.5 ET, 3/8" IT.	502 977
Replacement O-ring (20 x 2.5)	018 893

**3/8" extension lances**

	Art. no.
Length: 250 mm; 3/8" ET / 3/8" ET	502 970
Length: 800 mm; 3/8" ET / 3/8" ET	502 971
Length: 1,500 mm; 3/8" ET / 3/8" ET	502 972
Length: 2,000 mm; 3/8" ET / 3/8" ET	502 973



For safety reasons, a spray lance measuring 250 mm or more must always be chosen so that, in combination with the 600 bar high-pressure gun, an overall length of approx. 800 mm is reached.

Nozzle carrier for 3/8" extension lances

	Art. no.
For shape A and B nozzles. Connection: 3/8" IT, directly on to the extension lance.	502 974
For shape C and D plug-in nozzles. Connection: 3/8" IT, directly on to the extension lance.	502 952
O-ring for shape C and D plug-in nozzles	484 295
Support ring for shape C and D plug-in nozzles	489 307
For shape F rotor nozzles up to 500 bar. Connection: 3/8" IT, directly on to the extension lance. With 1/4" ET outlet.	503 011



High-pressure nozzles

Round-jet nozzles, plug-in type (shape C)

Water-jetting system	Designation	Art. no.
500me + 500mg + 500md	1.0	438 669
500th + 500me-30	1.4	438 675



Flat-jet nozzles, plug-in type (shape D)

Water-jetting system	Designation	Art. no.
15° jet angle (standard)		
500me + 500mg + 500md	1.2	431 316
500th + 500me-30	1.6	436 922
30° jet angle		
500me + 500mg + 500md	1.2	438 676
500th + 500me-30	1.6	438 679



Rotating nozzles (shape F)

Superior stainless steel finish. Connection: 1/4" IT. An adapter is required for connection to 3/8" spray lances!

Water-jetting system	Designation	Art. no.
500me + 500mg + 500md	030	445 940
500th + 500me-30	055	427 149
Adapter and nozzle pipe		
Adapter with 1/4" ET outlet. Connection: 3/8" IT, directly on to the extension lance.		503 011
Complete nozzle pipe; 300 mm; M24 ET - 1/4 IT		482 900



i **Please note:** Always start rotor nozzles downwards! Otherwise damage may be caused to the rotor.

Repair kits

For shape F rotating nozzles. Contain replacement nozzles and ceramic seat. Specifically designed for the high water temperatures of DYNAJET water-jetting systems.

Nozzle type	Designation	Art. no.
Nozzle 445 940	030	445 941
Nozzle 466 607	050	466 666
Nozzle 427 149	055	431 486
O-ring for all nozzle sizes		460 442



Water-sandblasting systems and accessories

WSS 1000 water-sandblasting system

Professional sandblasting head for continuous deployment. Circular arrangement of the high-pressure nozzles. Central sand feed. Tungsten carbide focus nozzle. Connection: 9/16" - 18 UNF IT. Accommodates 3 high-pressure nozzles (shape E).

	Art. no.
WSS 1000 (shape E nozzle inserts not included)	435 111
Replacement tungsten carbide focus nozzle for WSS 1000	450 815



Adapter nipple for WSS 1000

	Art. no.
Connects the WSS 1000 to 3/8" spray lances. Inlet: 3/8" IT, outlet: 9/16"- 18 UNF ET.	506 527



Nozzle sets (shape E) for WSS 1000 water-sandblasting system

High-pressure nozzle sets for WSS 1000 sandblasting head. Each set consists of 3 nozzles.

Water-jetting system	Designation	Art. no.
500me + 500mg + 500md	0.55	453 077
500th + 500me-30	0.8	447 559



Special tool

	Art. no.
For replacing shape E nozzles for WSS 1000	438 684





Blasting-abrasive suction pipe for WSS 1000 Art. no.

Offering stepless quantity adjustment of the blasting medium	435 113
--	---------

Blasting-abrasive suction hose for WSS 1000 Art. no.

With spiral inlay; length: approx. 12 m	414 037
Clamp for blasting-abrasive suction hose. 2 required (1 on the blasting head and 1 on the suction pipe).	001 422



Double-spray lance Art. no.

For direct connection to the high-pressure gun. Pressure can be regulated steplessly with the handgrip via the valve. Length: approx. 650 mm. 2 nozzle carriers for shape A or B nozzles. Equipped with a shape B low-pressure nozzle (506 422). Connection: M24 x 1.5 ET. High-pressure nozzle not included.	533 159
Spare-part kit for valve	505 583

High-pressure nozzles (shape B) with 15° jet angle for double-spray lance

One nozzle is required.

Water-jetting system	Designation	Art. no.
500me + 500mg + 500md	1503	449 011
500th + 500me-30	15055	433 537

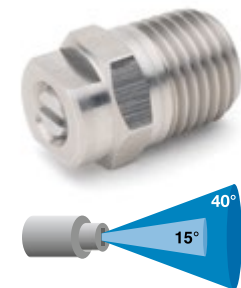

Floor-cleaning system and accessories

DYNAJET DFS 500 floor-cleaning system

With 500 bar, perfect for splash-free cleaning of surfaces such as floors, roads or cycle paths. Fully equipped with high-pressure gun. Nozzles, O-ring and support ring not included.

- **Efficient and powerful:** Uses hot water up to 120 °C. 90° vacuum connection. Nozzle carriers to accommodate two shape D high-performance nozzles for maximum results.
- **Mobile and robust:** Four steerable, heat- and oil-resistant wheels for extra-smooth motion without jamming. Double walls. Height-adjustable for simple adaptation to surfaces. Folding handle for easy transportation and space-saving storage.
- **Superior and practical:** In stainless steel with welded stainless steel rotor. Splash guard to prevent the surrounding area from becoming dirty.



DFS 500	Data	Art. no.
Working pressure	Up to 500 bar	506 448
Flow rate	Max. 45 l/min	
Temperature	Max. 120 °C	
Diameter	520 mm	
Wheels	60 mm	
Connection	M24 x 1.5 ET	
Nozzles	2x shape D	
Replacement high-pressure swivel		501 579
Replacement gun		546 856

Nozzles (shape D) for DFS 500

Two identical nozzles are required.

Water-jetting system	Designation	Art. no.
15° jet angle		
500me + 500mg + 500md	0.85	498 398
500th + 500me-30	1.2	431 316
30° jet angle (DYNAJET recommendation)		
500me + 500mg + 500md	0.85	498 391
500th + 500me-30	1.2	438 676
O-ring and support ring		
O-ring for shape C and D plug-in nozzle carrier		484 295
Support ring for shape C and D plug-in nozzles		489 307



Pipe-cleaning accessories

F 500 foot valve

	Art. no.
To switch the high pressure on and off easily when cleaning pipes. Stainless steel casing. Inlet: M24 x 1.5 ET, outlet: M24 x 1.5 ET.	532 373



Hose lines, coupling and connecting nipple

DN 10. Connection: 2x M24 x 1.5 IT.

	Art. no.
Length: 10 m	503 954
Length: 25 m	503 955
Length: 50 m	524 382
Coupling as junction between high-pressure hose and connecting nipple. Connections: M24 x 1.5 ET, 3/8" ET.	546 802
Connecting nipple to connect coupling and pipe-cleaning nozzle. Inlet: 3/8" IT, outlet: 1/4" ET.	503 011



Pipe-cleaning nozzles

For direct connection to connecting nipple. Art. no. 503 011.

Standard nozzles

For all areas of application. Drilled as pulling nozzles for autonomous feed.

Water-jetting system	Pipe diameter	Art. no.
500me + 500mg + 500md	> 30 mm	467 183
500th + 500me-30	> 30 mm	427 074

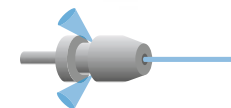

Rotating nozzles

For complete, all-round cleaning. Not available as pulling nozzles.

Water-jetting system	Pipe diameter	Art. no.
500me + 500mg + 500md	30-100 mm	485 667
500th + 500me-30	30-100 mm	427 073

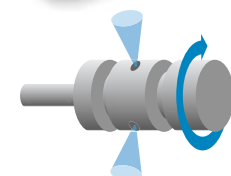

Heat exchanger cleaning accessories

Coupling

Art. no.

Between F 500 foot valve (art. no. 532 373) and connecting nipple. Inlet: M24 x 1.5 IT, outlet: 3/8" IT.

546 798



Connecting nipple

Art. no.

Between coupling and flexible lance. Inlet: 3/8" ET, outlet: M24 x 1.5 DKO ET.

445 117



Flexible lances

Hose connection inlet: M24 x 1.5 DKO IT. 10 m in length with marking before end of hose.

External diameter and connection thread	Type	Art. no.
10.5 mm; M7 ET	(4/2)	505 571
13 mm; 1/8" ET	(5/2)	505 574
16 mm; 1/4" ET	(6/2)	505 576



Pipe-cleaning nozzles, rigid

Drilled as pulling nozzles with front jet. Suitable for DYNAJET 500me-30 and 500th.

External diameter and connection thread	Type	Art. no.
10.5 mm; M7 IT	(4/2)	505 577
12 mm; 1/8" IT	(5/2)	505 578
16 mm; 1/4" IT	(6/2)	505 579



Pipe-cleaning nozzles, rotating

Drilled as pulling nozzles with front jet. Suitable for DYNAJET 500me-30 and 500th.

External diameter and connection thread	Type	Art. no.
10.5 mm; M7 IT	(4/2)	505 580
13 mm; 1/8" IT	(5/2)	505 581
16 mm; 1/4" IT	(6/2)	505 582



Other accessories up to 500 bar

600 bar high-pressure gun, short

Art. no.

In stainless steel with servo valve for simple and fatigue-proof operation. Inlet: M24 x 1.5 ET, outlet: 3/8" IT.

546 856

Spare-part kit for high-pressure gun

502 434



Couplings / rapid-release couplings

Connection	Picture	Art.-Nr.
M24 x 1.5 ET, 3/8" IT	1	546 801
M24 x 1.5 IT, 3/8" IT	2	546 798
M24 x 1.5 IT, 3/8" ET	3	546 797
M24 x 1.5 ET, 3/8" ET	4	546 802
O-ring for rapid-release coupling M24 x 1.5		546 637
Support ring for rapid-release coupling M24 x 1.5		502 980
O-ring for M24 x 1.5 ET, 20 x 2.5 (for 1 and 4)		546 641



Hose drum

Art. no.

Loose drum for flexible installation. Includes hand crank, high-pressure swivel, mounting plate and locking mechanism. Inlet: M24 x 1.5 ET, outlet: M20 x 1.5 ET. Suitable for max. 50m high-pressure hose (DN 10).

532 960

Hose line for hose drum or DYNAJET 500th trailer. DN 10. Length: 50 m.

546 794



Distributor

Art. no.

For parallel operation of one DYNAJET water-jetting system by two consumers. 1x inlet M24 x 1.5 ET, 2x outlet M24 x 1.5 ET. Can also be used as a collecting component for two pumps to one consumer (only possible with DYNAJET water-jetting systems equipped with an unloader valve without hose-pressure drop-down system).

523 638





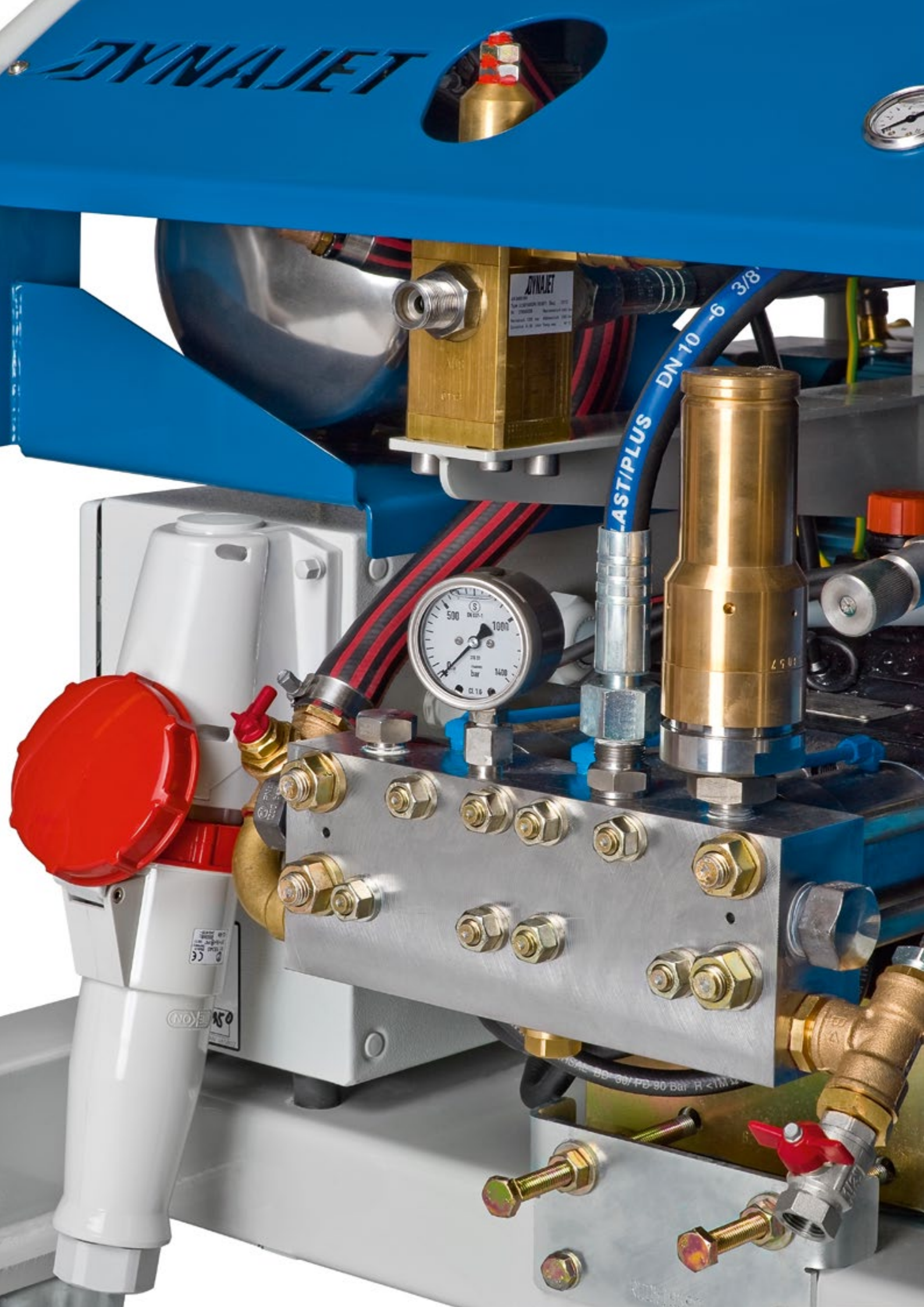

Water-jetting systems and accessories up to 1,000 bar (14,500 PSI)

Water-jetting systems up to 1,000 bar

The pressure class up to 1,000 bar (14,500 PSI) gives you full performance for the toughest cleaning tasks and demanding renovation projects. DYNAJET offers powerful trolleys, trailers and stationary water-jetting systems to go with the

appropriate area of deployment. The high quality of DYNAJET's products makes for reliable operation even when they are used almost non-stop in very rough conditions.

Highlights of the 1,000 bar water-jetting systems



High performance and resilience: superior workmanship for professional deployment and a long service life



Precise adjustment: the working pressure can be regulated up to 800 bar (11,600 PSI)



Safety and comfort: intuitive control, safety valves and emergency shutdown switch



Optimum mobility: lifting eyes for easy transportation on construction sites

Trolleys up to 1,000 bar

Offering a working pressure of up to 1,000 bar (14,500 PSI), the cold-water high-pressure cleaners in the "me" class rank among DYNAJET's strongest trolleys. Thanks to their superior workmanship and powerful electric motors, these trolleys

are particularly suitable for tasks such as effective cleaning of shuttering, construction machinery or installations. They are also ideal for paint removal or renovation projects.

Standard accessories included with DYNAJET trolleys up to 1,000 bar:

- 10 m high-pressure hose for hot and cold water
- High-pressure gun with spray lance
- Nozzle carrier and 15° flat-jet nozzle

Depending on where the machines are to be used, there are special voltages and frequencies available for the electric motors – such as the 440 V / 60 Hz version (see machine list on pg. 94).



800me-20



1000me

Type	Cold-water high-pressure cleaner
Working pressure	Stepless up to 800 bar (11,600 PSI)
Flow rate	Up to 20 l/min (5.28 USgal/min)
Pump	Triples plunger pump with packing seal, rinsing / cooling and carbide plungers
Motor	Electric motor 400 V, 50 Hz, IP55 / 63 A CEE
Motor output	30 kW (41 HP)
Speed of motor & pump / Drive	1,450/850 rpm / Fan belt
Discharge coupling (water)	M24 x 1.5 DK0
Unladen weight	560 kg
Dimensions (L x W x H)	116 x 80 x 130 cm
Article number	1 585 010

Type	Cold-water high-pressure cleaner
Working pressure	1,000 bar (14,500 PSI)
Flow rate	17 l/min (4.49 USgal/min)
Pump	Triples plunger pump with packing seal, rinsing / cooling and carbide plungers
Motor	Electric motor 400 V, 50 Hz, IP55 / 63 A CEE
Motor output	30 kW (41 HP)
Speed of motor & pump / Drive	1,450/850 rpm / Fan belt
Discharge coupling (water)	M24 x 1.5 DK0
Unladen weight	560 kg
Dimensions (L x W x H)	116 x 80 x 130 cm
Article number	1 585 050

Type	Cold-water high-pressure cleaner
Working pressure	1,000 bar (14,500 PSI)
Flow rate	17 l/min (4.49 USgal/min)
Pump	Triples plunger pump with packing seal, rinsing / cooling and carbide plungers
Motor	Electric motor 400 V, 50 Hz, IP55 / 63 A CEE
Motor output	30 kW (41 HP)
Speed of motor & pump / Drive	1,450/850 rpm / Fan belt
Discharge coupling (water)	M24 x 1.5 DK0
Unladen weight	560 kg
Dimensions (L x W x H)	116 x 80 x 130 cm
Article number	1 585 050

Standard features of DYNAJET trolleys up to 1,000 bar:

- Automatic pressure regulation with bypass line with hose-pressure drop-down system
- Buffer tank, separation from the water network, water stabilisation and stainless steel booster pump
- High-pressure and suction-pressure manometer
- Operating-hours counter, supply-pressure monitor and temperature monitor
- Automatic star/delta switch and motor-safety switch
- Antifreeze function, stainless steel water filter and safety valve
- Connector socket for plugs (63 A)



For more detailed information about DYNAJET 1,000 bar water-jetting systems, please visit:

→ www.dyna-jet.com/1000bar

All DYNAJET water-jetting system models and versions are listed as of pg. 94.

**DYNAJET 1000me**

The DYNAJET 1000me is the first 1,000 bar (14,500 PSI) water-jetting system without a control cable and with a dry-stop gun, making the high-pressure cleaner unique in its category. When the dry-stop gun is switched off, the water pressure is interrupted and the gun is sealed instantly.

A special valve system ensures that the water circulates without pressure in a separate circuit, which means that it is possible to interrupt work without any water leakage from the gun or any water loss. This simplifies work and saves water.

Trailers & installation modules up to 1,000 bar



The DYNAJET 800th wireless and DYNAJET 1000t trailers can be used for all purposes and have been designed for heavy duty, while offering a high level of performance and safety. With a working pressure of up to 800 bar, the DYNAJET 800th wireless is the most powerful hot-water high-pressure cleaner in the DYNAJET family. Even more working pressure – up to 1,000 bar – is available from the DYNAJET 1000t cold-water high-pressure cleaner.

Advantages:

- Powerful cold- and hot-water high-pressure cleaners for flexible deployment at any location.
- Ready for operation immediately thanks to water tank.
- Stepless pressure adjustment up to 800 bar enables cleaning performance to be optimally adapted to every object.
- No control cable necessary for the gun.

Standard accessories

High-pressure gun with spray lance (overall length: approx. 800 mm), nozzle carrier, 15° flat-jet nozzle, storage box and document case.

Standard features

2x high-performance hot-water generators (800th only), 12 V socket, 2x 10 m high-pressure hose on storage drum, 25 m low-pressure supply hose on hose drum, safety valve, automatic pressure regulation with hose-pressure drop-down system, 1,000 l (264.55 USgal) water-storage tank and lifting eye.

Optional features

- **DYNAJET radio remote control:** Control of key functions within a radius of up to 350 m.
- **Vario Control:** Electronic speed regulation via control box and reduction of idle speed.
- **Water-softening system:** Reduces maintenance and protects the burner.
- **Safety package for chemical installations and refineries:** Spark arrestors for motor and burners, connection for external emergency shutdown switch and battery disconnecting switch.
- **External emergency shutdown switch:** With cable drum and 50 m cable.





800sh

	800th	1000t
Type	Hot- and cold-water high-pressure cleaner	Cold-water high-pressure cleaner
Working pressure	Stepless up to 800 bar (11,600 PSI)	Up to 1,000 bar (14,500 PSI)
Flow rate	10 - 21 l/min (2.65 - 5.56 USgal/min)	8 - 17 l/min (2.11 - 4.49 USgal/min)
Pump	Triplex plunger pump with packing seal, rinsing / cooling and carbide plungers	Triplex plunger pump with packing seal, rinsing / cooling and carbide plungers
Motor	Deutz 3-cylinder diesel (oil-cooled)	Deutz 3-cylinder diesel (oil-cooled)
Motor output	34 kW (46.2 HP)	34 kW (46.2 HP)
Speed of motor & pump / Drive	2,250/800 rpm / Belt	2,250/850 rpm / Belt
Fuel consumption	Approx. 10 l/h (2.65 USgal/h)	Approx. 10 l/h (2.65 USgal/h)
Volume of fuel tank	70 l (18.52 USgal) / 105 l (27.78 USgal)	70 l (18.52 USgal) / 105 l (27.78 USgal)
Volume of water tank	1,000 l (264.55 USgal)	1,000 l (264.55 USgal)
Discharge coupling (water)	M24 x 1.5 DK0	M24 x 1.5 DK0
Heat output of oil burners	2x 65 kW	-
Consumption of oil burners	Approx. 7 l/h (1.85 USgal/h)	-
Chassis	Single-axle trailer with brake	Single-axle trailer with brake
Unladen weight	1,640 kg	1,640 kg
Dimensions (L x W x H)	371 x 207 x 208	371 x 207 x 208
Dimensions when open (L x W x H)	398 x 207 x 277	398 x 207 x 277
Article number	1 529 080	1 573 040
Stationary version	800sh, article number 1 529 033	-



DYNAJET
435111W

Water-jetting systems and accessories up to 1,000 bar (14,500 PSI)

Accessories up to 1,000 bar

DYNAJET original accessories meet high quality standards and are perfectly attuned to numerous applications. They specifically optimise work efficiency and cleaning depth in line with their area of deployment. In addition to accessory

sets, hoses, lances, guns and nozzles, DYNAJET also offers special accessories for applications such as water-sandblasting, or cleaning floors, containers, pipes or heat exchangers.



For more detailed information about DYNAJET 1,000 bar accessories, please visit:

→ www.dyna-jet.com/acc1000

Abbreviations used

DN: Diameter (mm)

PN: Max. operating pressure (bar/PSI)

IT: Internal thread

ET: External thread

Art. no.: Article number

Accessory sets

Rotating nozzle system

Set consisting of spray lance, coupling and rotating nozzle.

Water-jetting system	Art. no.
800me-20	530 851
800th wireless	531 125
1000me-17, 1000t	546 724



WSS 1000 water-sandblasting system

Set consisting of spray lance, coupling, spray head incl. nozzle set, and suction hose with suction pipe.

Water-jetting system	Art. no.
800me-20, 800th wireless	487 234
1000me-17, 1000t	446 723



Water-jetting systems and accessories up to 1,000 bar (14,500 PSI)

1,200 bar high-pressure gun – complete set

Stainless steel gun with servo valve for minimised holding force. Side handgrip that can be secured in various positions. Integrated swivel joint. Fully insulated and suitable for hot water up to 150 °C. Overall length: approx. 1,100 mm. Max. 60 l/min (15.90 USgal/min). Connections: M24 x 1.5 ET / M24 x 1.5 IT.



Water-jetting system

Art. no.

800me, 1000me, 800th wireless

522 605

Hose lines and accessories

Extension hoses

DN 10 for up to 100 °C, including whip check. Connection: 2x M24 x 1.5 DKO IT.

Hose lines

Art. no.

Length: 10 m

477 853

Length: 20 m

482 089

Replacement O-ring

485 381



Whip check

Prevents hose whip if the connection between the hose line and the machine separates while under pressure.

Art. no.

Variable for all hose sizes.

547 496



Hose connector

Art. no.

Double nipple for coupling two high-pressure hoses. Connections: 2x M24 x 1.5 DKO ET. PN: 1,800 bar (26,100 PSI).

437 756



Swivel joint

Art. no.

Prevents hose lines from twisting. Screwed in directly between the high-pressure gun and the high-pressure hose line. Connections: M26 x 1.5 ET ground surface seal (gun connection) and M24 x 1.5 DKO ET (hose connection). PN: 1,600 bar (23,200 PSI). Max. 95 °C.

494 275

**Distributor**

Art. no.

For parallel operation of one DYNAJET water-jetting system by two consumers. Connections: 1x inlet M24 x 1.5 DKO ET, 2x outlet M24 x 1.5 DKO ET.

533 163



Guns and accessories

1,200 bar high-pressure gun

With servo trigger and mechanical shut-off valve. Connections: inlet: M24 x 1.5 DKO ET, outlet: M26 x 1.5 IT.

Art. no.

High-pressure gun

522 604

Set of 1,200 bar O-ring/
support ring seals

539 484

Special tool for disassembly

528 283

**Shoulder support**

Art. no.

For 1,200 bar high-pressure gun to absorb reaction forces. Mandatory for reaction forces greater than 150 newtons.

519 001



Water-jetting systems and accessories up to 1,000 bar (14,500 PSI)

High-pressure gun-lances, pressure ring and pressure screw

For fixing on the high-pressure gun. External diameter: 14.3 mm.

Spanner flat on both ends: 12 mm. Internal diameter: 8 mm.

Connection thread: 9/16"-18 UNF-LH ET. PN: 1,600 bar.



Gun lances	Art. no.
Length: 350 mm	482 505
Length: 800 mm	482 515
Length: 1,200 mm	482 516
Length: 2,000 mm	482 517
Pressure ring and pressure screw	
Pressure ring for screwing together ultrahigh-pressure connections. Anti-vibration. Thread: 9/16"-18 UNF-LH IT.	474 636
Pressure screw for screwing together ultrahigh-pressure connections. Anti-vibration in combination with pressure ring. Thread: M26 x 1.5 ET.	474 635



For safety reasons, a spray lance must be chosen so that, in combination with the 1,200 bar (17,400 PSI) high-pressure gun, an overall length of at least 800 mm is reached.

Handgrip	Art. no.
For side-mounting on the high-pressure gun-lance. Can be secured in any position.	519 707



Protective grip	Art. no.
For protection on the high-pressure gun-lance	489 336



Control cable
For accessories with remote control via electronic signal.
Metal coupling and connector.

	Art. no.
25 m; loose, with coupling and connector	511 694
50 m; loose, with coupling and connector	511 696
25 m; on drum, with coupling, locking mechanism and connector	514 733
50 m; on drum, with coupling, locking mechanism and connector	514 734



Single-nozzle carrier for shape C and D nozzle inserts

To accommodate 1x shape C or D plug-in nozzle insert. Light in weight.

Consists of 1x basic body and 1x union nut, complete with O-ring and support ring.

PN: 1,500 bar (21,750 PSI). Connection: 9/16"-18 UNF-LH IT. Nozzle not included.

	Art. no.
Single-nozzle carrier	488 299
O-ring for shape C and D plug-in nozzles	484 295
Support ring for shape C and D plug-in nozzles	489 307



High-pressure nozzles

Round-jet nozzles, plug-in type (shape C)

In vacuum-hardened stainless steel. For up to 1,500 bar.

Water-jetting system	Designation	Art. no.
800me, 800th wireless	1.0	438 669
1000me, 1000t	1.1	438 670



Flat-jet nozzles, plug-in type (shape D)

In vacuum-hardened stainless steel. For up to 1,500 bar.

Water-jetting system	Designation	Art. no.
15° jet angle		
800me, 800th wireless	1.1	498 401
1000me, 1000t	1.2	431 316
30° jet angle		
800me, 800th wireless	1,2	438 676
1000me, 1000t	1.1	498 394

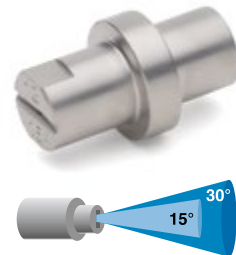



Please note: Always start rotor nozzles downwards!
Otherwise damage may be caused to the rotor.

Rotating nozzles (shape F), turbo, for up to 800 bar (11,600 PSI)

Can be mounted straight on to the spray lance. High speed without brake for rapid surface preparation. Connection: 9/16"-18 UNF-LH IT. Max. 80 °C.

Water-jetting system	Designation	Art. no.
30° jet angle		
800me	1.05	528 432
800th, 800th wireless	1.10	435 110



Rotating nozzle (shape F), turbo, for up to 1,500 bar (21,750 PSI)

This all-purpose nozzle with an extremely hard spot-jet that is self-driven via nozzle reaction force, is ideal for both surface cleaning and removal tasks. Connection: 9/16"-18 UNF-LH.

Water-jetting system	Designation	Art. no.
30° jet angle		
1000me, 1000t	0.95	546 732



Repair kits

For shape F rotating nozzles. Specifically designed for the high water temperatures of DYNAJET water-jetting systems.

Nozzle type	Designation	Art. no.
Nozzle 528 432	1.05	528 434
Nozzle 435 110	1.10	443 326
Nozzle 546 732	0.95	546 733



RDS-Easy 3.000-3 rotating nozzle system

Ultrahigh-pressure nozzle system for up to 3,000 bar. Leak-free. Multi-jet head, self-driven via nozzle reaction force. Speed adjustment via contact-free magnetic brake. Approx. 1,000 - 4,000 rpm. Weighs only approx. 1.8 kg. Nozzle carrier head to accommodate max. 3 shape G nozzle inserts (M10). Connection: 9/16"-18 UNF-LH IT. Nozzle inserts not included.

Nozzle type	Art. no.
RDS-Easy 3.000-3	544 735
Suggestion for standard configuration:	
1000me, 1000t: 2x 0,55, 1x 0,50	2x 457 456 1x 455 458



Water-sandblasting systems and accessories

WSS 1000 water-sandblasting system

Professional sandblasting head for continuous deployment. Circular arrangement of the high-pressure nozzles. Central sand feed. Tungsten carbide focus nozzle. Connection: 9/16"-18 UNF IT. Accommodates 3 high-pressure nozzles (shape E).



	Art. no.
WSS 1000 (shape E nozzles not included)	435 111
Replacement tungsten carbide focus nozzle	450 815

Nozzle sets (shape E) for WSS 1000 water-sandblasting system

High-pressure nozzle sets for WSS 1000 sandblasting head. Each set consists of 3 nozzles.

Water-jetting system	Designation	Art. no.
800me, 800th wireless	0.6	447 560
1000me, 1000t	0.7	447 561



Special tool

	Art.-Nr.
For replacing shape E nozzles for WSS 1000	438 684



Blasting-abrasive suction pipe for WSS 1000

	Art. no.
Offering stepless quantity adjustment of the blasting medium	435 113

Blasting-abrasive suction hose for WSS 1000

	Art. no.
With spiral inlay; length: approx. 12 m	414 037
Clamp for blasting-abrasive suction hose. 2 required (1 on the blasting head and 1 on the suction pipe).	001 422



Cleaning tanks, pipes and heat exchangers

DYNAJET TWS 1000 tank-washing system

For interior cleaning of tanks, drums, barrels and containers. With a working pressure of up to 800 bar and a flow rate of 21 l/min (5.56 USgal/min). Three-dimensional cleaning via nozzle rotor with 2 high-pressure nozzles. Driven by nozzle reaction force. Speed adjustment via magnetic brake. Fully equipped with hose connection M24 x 1.5 DKO ET.



	Art. no.
TWS 1000	461 074

F 1200 foot valve

F 1200 foot valve for 800me, 800th wireless, 1000me, 1000t

Art. no.

Spare-part kit for F 1200 foot valve

532 110

489 339



Flexible lances

Hose connection inlet: M24 x 1.5 DKO IT. 10 m in length with marking before end of hose.

External diameter and connection thread	Type	Art. no.
10.5 mm; M7 ET	(4/2)	505 571
13 mm; 1/8" ET	(5/2)	505 574
16 mm; 1/4" ET	(6/2)	505 576



DYNAJET hose catcher

A safety device for manual interior cleaning of pipes and heat exchangers with flexible lances and hoses. Stops the nozzle escaping from the pipes to be cleaned. Clamp-secured. Suitable for 4/2, 5/2 and 6/2 hoses.

Art. no.

505 570



Pipe-cleaning nozzles, rigid

Drilled as pulling nozzles with front jet for 800me and 800th.

External diameter and connection thread	Type	Art. no.
10.5 mm; M7 IT	(4/2)	On request
14 mm; 1/8" IT	(5/2)	538 773
17 mm; 1/4" IT	(6/2)	538 799

**Pipe-cleaning nozzles, rotating**

Drilled as pulling nozzles for 800me and 800th.

External diameter and connection thread	Type	Art. no.
13 mm; 1/8" IT	(5/2)	538 774
16 mm; 1/4" IT	(6/2)	538 806



Floor-cleaning system and accessories

DYNAJET DFS 1200 floor-cleaning system

Floor cleaner for rapid removal tasks over large areas or to clean surfaces of all types. Removal width: approx. 260 mm. PN: 1,200 bar. Complete with four large, stable wheels.

With nozzle rotor to accommodate several shape G nozzles. Includes electronic signal and short cable with connector. Safety trigger with lock to prevent the gun from going off accidentally. Suitable for hot water. Stable, robust industrial design. Driven by nozzle reaction force through the oblique positioning of the high-pressure nozzles. Connection: M24 x 1.5 DK0 ET. Nozzle sets not included.

	Art. no.
DFS 1200 without vacuum connection (shown here)	505 584
DFS 1200 with vacuum connection	505 585



Other accessories

DYNAJET mobile filter station

The filter unit is connected via a short hose right in front of the supply connection on the high-pressure unit. Suitable for all DYNAJET water-jetting systems. 2 x 2 filter housing (9 3/4") in parallel operation. Connection: 3/4" GEKA coupling. Outlet: 3/4" GEKA coupling. 2x capped coupling. Filter inserts not included. Advantages:

- **Effective and flexible:** Long-lasting protection of the water-jetting system. Large filter area in 2 x 2 parallel operation for increased duration of deployment and minimised pressure loss. The filter unit adapts to all degrees of dirt and all machine types.
- **Superior and practical:** Corrosion-free and weight-reduced aluminium construction. Designed for difficult operating conditions. Filters can be changed very quickly. Stands securely. Space to store 4 replacement filter inserts. The stainless steel filters are washable.

[DYNAJET mobile filter station →](#)

DYNAJET filter station	Data	Art. no.
Supply pressure (max.)	8 bar at 20 °C	494 706
Temperature (max.)	50 °C at 3 bar	
Flow rate (max.)	40 l/min	
Weight	Approx. 11 kg	
Dimensions (L x W x H)	435 x 340 x 404 mm	

Filter inserts, 9 3/4" in size	Fineness	Art. no.
Depth filter	10 µm	496 557
Depth filter	50 µm	494 759
Stainless steel filter	80 µm	495 982

Accessory packages for filter station	Art. no.
Accessory package 1: 6x depth filter 10 µm, 2x stainless steel filter 80 µm and 2 m supply hose	496 575
Accessory package 2: 6x depth filter 50 µm, 2x stainless steel filter 80 µm and 2 m supply hose	496 576





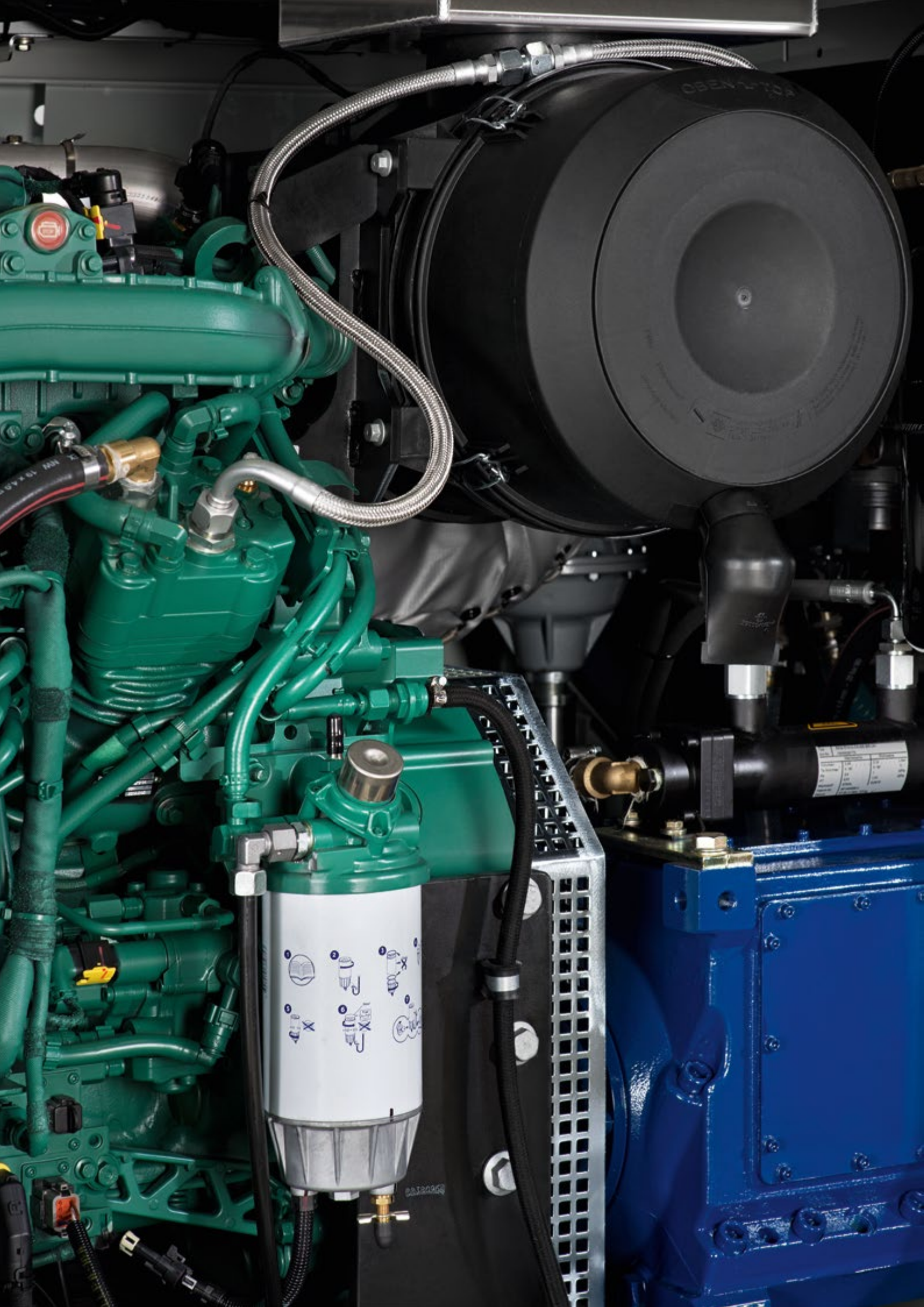

Water-jetting systems and accessories up to 3,000 bar (43,500 PSI)

Water-jetting systems up to 3,000 bar

Welcome to DYNAJET's premium class. The innovative DYNAJET UHP 220 ultrahigh-pressure unit, offering a working pressure of up to 3,000 bar (43,500 PSI), ranks among the most powerful of all the DYNAJET water-jetting systems.

The DYNAJET UHP 220 is therefore ideal for applications such as paint removal, derusting, cleaning heat exchangers, surface preparation, concrete restoration and concrete removal.

Highlights of the 3,000 bar water-jetting systems



More power and safety: ultrahigh-pressure pump with full lift safety valve



DYNAJET EASY CONTROL: innovative control with touch screen and colour display



The latest emissions standard: complies with TIER 4f; integrated spark arrester



Optimum mobility: four lifting eyes for fast transportation on construction sites

Trailers & stationary units up to 3,000 bar



The DYNJET UHP 220 cold-water ultrahigh-pressure cleaner convinces with the highest level of functionality, efficiency and economy. The ultrahigh-pressure unit not only fulfils the latest safety and emissions standards (TIER 4F) but, with its numerous innovations, makes water-jetting more ergonomic, more efficient and more sustainable.

In addition to the two hoods in tried-and-tested targa design, the DYNJET UHP 220 has two large maintenance doors so that you can get to all the key engine, pump, storage area and operating elements quickly and easily. What is more, the trailer is a true miracle of space: a large storage area and an additional work surface, including a vice, have been integrated and are quickly accessible.

Standard features

Long-life 4-cylinder VOLVO PENTA diesel motor, triplex high-pressure plunger pump with carbide plungers, power-end cooling, full lift safety valve, compressed-air connection, water temperature monitor, buffer tank with booster pump incl. filter and suction-pressure gauge, protection and leak tray, DYNJET EASY CONTROL with simple selection of operating modes, enabling pressure or speed to be preset freely, graphical colour display, master/slave mode for synchronous operation of 2 water-jetting systems, spark arrestor, connection for external emergency shutdown switch, 2 hoods and 2 doors (targa system), chassis and sound-insulation hoods, document case, and EU approval for road use.

Optional features

- **External emergency shutdown switch:** With cable drum and 50 m cable.
- **Storage area package:** Optional drawer to keep things tidy.
- **WiFi module:** For remote diagnostics.
- **Cable remote control device:** For robot operation.



View the DYNJET UHP 220 in a film:
→ www.uhp220.com

For more detailed information about the DYNJET UHP 220, please visit:
→ www.dyna-jet.com/3000bar

All DYNJET water-jetting system models and versions are listed as of pg. 96.



UHP 220

Type	Cold-water ultrahigh-pressure unit
Working pressure	Up to 2,800 bar (40,600 PSI)
Flow rate	Max. 27 l/min (7.13 USgal/min)
Pump	Low-speed ultrahigh-pressure pump with 3 carbide plungers, integrated reduction gearbox, power-end cooler and pressure oil lubrication
Motor	VOLVO PENTA 4-cylinder diesel, water-cooled; 5,200 cm ³
Motor output	160 kW (220 HP)
Speed of motor & pump / Drive	2,065/500 rpm / Gearbox
Fuel consumption	Approx. 21 l/h (5.56 USgal/h)
Volume of fuel tank	200 l (52.83 USgal)
Volume of urea tank	25 l (6.60 USgal)
Urea consumption	Approx. 1.05 l/h (0.27 USgal/h)
Discharge coupling (water)	9/16"-18 UNF LH IT or DYNAJET EC Easy Connect
Chassis	2-axle trailer
Unladen weight	2,690 kg
Dimensions (L x W x H)	467 x 197 x 218 cm
Dimensions when open (L x W x H)	487 x 310 x 254 cm
Article number	1 610 040
Stationary version	UHP 220 s, Article number 1 610 140



Water-jetting systems and accessories up to 3,000 bar (43,500 PSI)

Accessories up to 3,000 bar

DYNAJET original accessories meet high quality standards and are perfectly attuned to numerous applications. They specifically optimise work efficiency and cleaning depth in line with their area of deployment. In addition to

accessory sets, hoses, lances, guns and nozzles, DYNAJET also offers special accessories for applications such as water-sandblasting, or cleaning floors, containers, pipes or heat exchangers.



For more detailed information about DYNAJET 3,000 bar accessories, please visit:

→ www.dyna-jet.com/acc3000

Abbreviations used

DN: Diameter (mm)

PN: Max. operating pressure (bar/PSI)

IT: Internal thread

ET: External thread

Art. no.: Article number

Accessory sets



Ultrahigh-pressure lance – complete set, basic

Lance: SL 3,000 bar spray lance, complete with shoulder support, 800 mm lance pipe, handgrip, pressure screw and pressure ring, plus anti-seize lubricant

Nozzles: Nozzle carrier incl. 2 shape G round-jet nozzles

Hose line: 20 m; DN 8; 2,800 bar incl. adapter, safety coupling and whip check

Control cable: 25 m

Art. no.

Complete set, basic

533 098

Ultrahigh-pressure lance – complete set, power

Art. no.

As "complete set, basic", plus RDS Easy 3.000-6 rotating nozzle system incl. 6 shape G round-jet nozzles

533 099



Hose lines and accessories

Ultrahigh-pressure hose lines

With sealing nipple for EC Easy Connect rapid connection system. Includes protective hose with burst- and rip-out-protection function, and whip check.

Hose lines	Art. no.
2,000 bar; DN 8; length: 20 m	526 539
2,800 bar; DN 5; length: 5 m	526 536
2,800 bar; DN 8; length: 10 m	526 537
2,800 bar; DN 8; length: 20 m	526 538
O-ring for sealing nipple	526 356
Support ring for sealing nipple	526 357



Hose connector and couplings

Hose connector and couplings	Art. no.	
EC hose connector, DN 5 and DN 8	526 352	1
Safety coupling for EC hose connector, DN 5 and DN 8 hoses	526 351	2
EC safety coupling for pump and lance connection, DN 5 and DN 8	526 353	3
EC adapter for pump outlet and lance M26 x 1.5	526 354	4
Protective cap for EC hose nipple	526 355	5
Hose whip check	547 496	6



Guns and accessories

SL 3,000 bar spray lance with sensor

Lance handle for PN 3,000 bar with electronic signal. Short cable with connector. Safety trigger with lock to prevent the gun from triggering accidentally. Connections: 2x M26 x 1.5 IT. Pressure rings and pressure screws not included.

	Art. no.
Spray lance	514 732
Replacement contact switch with short cable and metal connector	512 224



Shoulder support

Art. no.

For SL 3,000 bar high-pressure lance to absorb reaction forces. Mandatory for reaction forces greater than 150 newtons.

519 001

**High-pressure lance pipes, pressure ring and pressure screw**

For fixing straight on to the spray lance. External diameter: 14.3 mm. Spanner flat on both ends: 12 mm. Internal diameter: 5 mm. Connection thread on both ends: 9/16"-UNF-LH ET. PN: 3,200 bar (46,400 PSI).



Lance pipes

Art. no.

Length: 350 mm	482 518
Length: 800 mm	482 519
Length: 1,200 mm	482 520
Length: 2,000 mm	482 521

Pressure ring and pressure screw

Pressure ring for screwing together ultrahigh-pressure connections. Anti-vibration. Thread: 9/16"-18 UNF-LH IT.	474 636
Pressure screw for screwing together ultrahigh-pressure connections. Anti-vibration in combination with pressure ring. Thread: M26 x 1.5 ET.	474 635



For safety reasons, a spray lance measuring 800 mm or more must always be chosen so that, in combination with the SL 3,000 bar (43,500 PSI) spray lance, an overall length of at least 800 mm is reached.

Handgrip

Art. no.

For side-mounting on the high-pressure gun-lance. Can be secured in any position.

519 707

**Control cable**

For accessories with remote control via electronic signal. Metal coupling and connector.

Art. no.

25 m; loose, with coupling and connector	511 694
50 m; loose, with coupling and connector	511 696
25 m; on drum, with coupling, locking mechanism and connector	514 733
50 m; on drum, with coupling, locking mechanism and connector	514 734



High-pressure nozzles

i The nozzle inserts for high-pressure nozzle systems are listed as examples only. For our complete selection, please visit:
 → www.dyna-jet.com/nozzles

Single-nozzle carrier for shape G nozzle inserts

Art. no.

Extremely light in weight to accommodate one shape G nozzle insert. M10 internal thread. PN: 2,800 bar. Connection: 9/16"-18 UNF-LH IT.	482 783
---	---------



Nozzle insert (shape G)

Round-jet nozzle with M10 external thread and hexagon socket. Nozzle insert with stainless steel intake cone, vacuum-hardened, sealing the nozzle insert via a fixed 59° bronze tube cone sealing system. Deployment up to 3,000 bar.

	Diameter	Art. no.
UHP 220, 2,800 bar/ 20 l/min	0.75	457 460



RDS-Easy 3.000-3 rotating nozzle system

Ultrahigh-pressure nozzle system for up to 3,000 bar. Leak-free. Multi-jet head, self-driven via nozzle reaction force. Speed adjustment via contact-free magnetic brake. Approx. 1,000 - 4,000 rpm. Weighs only approx. 1.8 kg. Nozzle carrier head to accommodate max. 3 shape G nozzle inserts (M10). Connection: 9/16"-18 UNF-LH IT. Nozzle inserts not included.

	Art. no.
RDS-Easy 3.000-3	544 735
Suggestion for standard configuration:	
UHP 220, 2,800 bar/20 l/min: 3x shape G nozzle insert, diameter: 0.45 mm	3x 457 455



RDS-Easy 3.000-6 rotating nozzle system

Ultrahigh-pressure nozzle system as RDS-Easy 3.000-3, with nozzle carrier head to accommodate max. 6 shape G nozzle inserts (M10).

	Art. no.
RDS-Easy 3.000-6	544 736
Suggestion for standard configuration:	
UHP 220, 2,800 bar/20 l/min: 6x shape G nozzle insert, diameter: 4x 0.30 mm and 2x 0.35 mm	4x 457 454 2x 455 457



Rotating nozzle, turbo, for up to 2,500 bar (36,250 PSI)

This all-purpose nozzle with an extremely hard spot-jet that is self-driven via nozzle reaction force, is ideal for both surface cleaning and removal tasks. Connection: 9/16"-18 UNF-LH IT.

Water-jetting system	Designation	Art. no.
UHP 220, 2,500 bar, 23.5 l/min	0.75	497 299
Repair kit for rotating nozzle (art. no. 497 304)	0.75	497 308



Pipe and heat exchanger cleaning

Electric foot switch

Complete with signal generator for remote control, with short cable and connector. Up to 3,000 bar.

	Art. no.
Foot switch	514 756
Replacement contact switch (sensor) with short cable and metal connector	512 224



Flexible lances

Hose connection inlet: 9/16" UNF-LH IT. 10 m in length with marking before end of hose.

External diameter and connection thread	DN	Art. no.
16 mm, 3/8"-24 LH	4	On request
19 mm, 3/8"-24 LH	5	On request
23 mm, 9/16" UNF-LH	8	On request



DYNAJET hose catcher

A safety device for manual interior cleaning of pipes and heat exchangers with flexible lances and hoses. Stops the nozzle escaping from the pipes to be cleaned. Clamp-secured. Suitable for 4/2, 5/2 and 6/2 hoses.

Art. no.

505 570



Pipe-cleaning nozzles, rotating, 2,800 bar

External diameter and connection thread

Pipe diameter

Art. no.

13 mm, 3/8"-24 LH	15-25 mm	On request
18 mm, 3/8"-24 LH	22-33 mm	On request
27 mm, 9/16"-18 LH	32-51 mm	On request

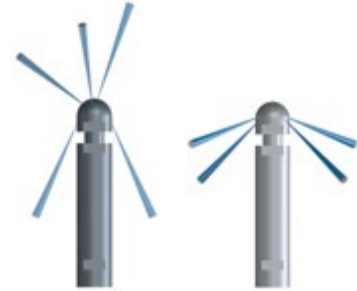

Floor-cleaning system and accessories

DYNAJET DFS 2800 floor-cleaning system

Floor cleaner for rapid removal tasks over large areas or to clean surfaces of all types. Removal width: approx. 260 mm. PN: 2,800 bar. Complete with four large, stable wheels.

With nozzle rotor to accommodate several shape G nozzles. Sensor for remote control. Connector socket for remote control cable. Suitable for hot water. Stable, robust industrial design. Driven by nozzle reaction force through the oblique positioning of the high-pressure nozzles. Connection: 9/16"-18 UNF-LH. Nozzle sets not included.



Art. no.

DFS 2800 without vacuum connection (shown here)	528 551
DFS 2800 with vacuum connection	528 591
Suggestion for standard configuration:	
UHP 220, 2,800 bar/27 l/min. Shape G nozzle insert, 2x 0.35 mm and 4x 0.40 mm	2x 455 457 4x 454 982

Other accessories

DYNAJET mobile filter station

The filter unit is connected via a short hose right in front of the supply connection of the high-pressure unit. Suitable for all DYNAJET water-jetting systems. 2 x 2 filter housing (9 3/4") in parallel operation. Connection: 3/4" GEKA coupling. Outlet: 3/4" GEKA coupling. 2x capped coupling. Filter inserts not included.

Advantages:

- **Effective and flexible:** Long-lasting protection of the water-jetting system. Large filter surface in 2 x 2 parallel operation for increased duration of deployment and minimised pressure loss. The filter unit adapts to all degrees of dirt and all machine types.
- **Superior and practical:** Corrosion-free and weight-reduced aluminium construction. Designed for difficult operating conditions. Filters can be changed very quickly. Stands securely. Space to store 4 replacement filter inserts. The stainless steel filters are washable.

DYNAJET filter station	Data	Art. no.
Supply pressure (max.)	8 bar at 20 °C	494 706
Temperature (max.)	50 °C at 3 bar	
Flow rate (max.)	40 l/ min	
Weight	Approx. 11 kg	
Dimensions (L x W x H)	435 x 340 x 404 mm	

Filter inserts, 9 3/4" in size	Fineness	Art. no.
Depth filter	10 µm	496 557
Depth filter	50 µm	494 759
Stainless steel filter	80 µm	495 982

Accessory packages for filter station	Art. no.
Accessory package 1: 6x depth filter 10 µm, 2x stainless steel filter 80 µm and 2 m supply hose	496 575
Accessory package 2: 6x depth filter 50 µm, 2x stainless steel filter 80 µm and 2 m supply hose	496 576





DYNAJET

DYNAJET personal protective equipment

Wearing perfect-quality, protective water-jetting clothing in flawless condition is essential and also prescribed by law.

DYNAJET offers a complete, high-quality assortment of the personal protective equipment required.



For more detailed information about DYNAJET personal protective equipment, please visit:

→ www.dyna-jet.com/protection

Size specifications

Order size	Height	Chest circumference
S (small)	158 – 170 cm	80 – 92 cm
M (medium)	170 – 182 cm	92 – 104 cm
L (large)	182 – 188 cm	104 – 116 cm
XL (extra large)	188 – 194 cm	116 – 124 cm
XXL (extra extra large)	194 – 200 cm	124 – 132 cm

Standard personal protective equipment

"Speedy" safety glasses

Art. no.

Scratch-proof, transparent polycarbonate shields. Length-adjustable arms.

414 094



Gloves

Lined, waterproof, breathable and heat-resistant.

Size

Art. no.

8	414 086
9	414 087
10	414 088
11	414 089



Personal protective equipment

Overalls

As protection against dirt and water. 100 % waterproof, with hood and collar.
The overalls do not protect against high pressure.

Size	Art. no.
L	426 895
XL	426 896



Overalls

Protective suit

As protection against dirt and water. 100 % waterproof. Two-piece:
jacket + dungarees. The suit does not protect against high pressure.

Size	Art. no.
M	414 067
L	414 068
XL	414 069
XXL	414 070



Protective suit

Safety boots for up to 800 bar²

For use when working with hand-guided water-jetting systems. Pressure-proof up to 800 bar at a lance reaction force of up to 117 newtons, with a nozzle size of up to 1.0 mm and a distance of up to 75 mm from the nozzle to the boot, at a feed rate of up to 0.2 m/sec and a water flow of up to 17.7 l/min.

Size	Art. no.
42	460 736
43	460 737
44	460 738
45	460 739
46	460 740
47	546 877



Safety helmet and accessories

	Art. no.
Safety helmet incl. hearing protectors and movable, anti-fog visor (polycarbonate). Design in accordance with CE, EN 397: 1195, EN 352-3.	427 305
Additional visor made of stainless steel	546 664
Replacement visor	546 665
Replacement hearing protectors	546 666



1 Protective clothing approved in accordance with directive 89/686/EEC and German BGR 191

2 Certified in accordance with test specification EN 345-1 – June 1997, German BGR 191, section 3.1.5.5.3 by centre no. 0299

Ultrahigh-pressure personal protective equipment

Dungarees¹

100 % waterproof. Up to 2,000 bar spot-jet, 3,000 bar rotor nozzle.

	Art. no.
S, M	460 747
L, XL	460 300
XXL	460 748



Dungarees

High-pressure apron

High-pressure apron¹

	Art. no.
Up to 500 bar rotor/flat-jet nozzle, 200 bar spot-jet nozzle. Weight: 1.5 kg.	546 668
Up to 2,000 bar spot-jet, 3,000 bar rotor nozzle. Weight: 1.7 kg.	476 881

Protective vest¹

100 % waterproof. Up to 2,000 bar spot-jet, 3,000 bar rotor nozzle.

	Art. no.
Size: M-XXL	460 302



Protective overboots¹

With clips to fasten them securely over the ordinary safety boots.

	Art. no.
Up to 1,000 bar spot-jet, 2,800 bar rotor nozzle.	460 757
Up to 2,000 bar spot-jet, 3,000 bar rotor nozzle.	460 306



Safety boots for up to 3,000 bar²

Size	Art. no.
42	499 649
43	499 650
44	499 651
45	499 652
46	499 653
47	499 654
48	499 655



DYNAJET Trolleys

		Pressure (bar)	Flow rate (l/min)	Power consumption	Plug	DYNAJET HELI-valve	Basic valve	Spark catcher 1	Automatic star-delta starter	Manual start/stop automatic	Manual throttle lever	Cable remote control
x	Standard	o	Optional feature									
1 488 016	DYNAJET 150me 400V/50Hz	150	42	400V/50Hz	32A CEE							
1 488 045	DYNAJET 150me 400V/60Hz	150	42	400V/60Hz	32A CEE							
1 488 039	DYNAJET 150me 400V/50Hz TTS	150	42	400V/50Hz	32A CEE			x	x			
1 488 058	DYNAJET 150me 3x 200V/50Hz	150	42	3x 200V/50Hz	63A CEE							
1 488 071	DYNAJET 150me 3x 220V/60Hz	150	42	3x 220V/60Hz	63A CEE							
1 489 002	DYNAJET 280me 400V/50Hz	280	13	400V/50Hz	16A CEE							
1 489 028	DYNAJET 280me 400V/60Hz	280	13	400V/60Hz	16A CEE							
1 486 021	DYNAJET 280mg	280	13									
1 488 003	DYNAJET 350me 400V/50Hz TTS	350	21	400V/50Hz	32A CEE							
1 488 123	DYNAJET 350me autom. star-delta starter	350	21	400V/50Hz	32A CEE			x	x			
1 488 032	DYNAJET 350me 400V/50Hz Heli	350	21	400V/50Hz	32A CEE			x				
1 488 149	DYNAJET 350me 400/60Hz	350	21	400V/50Hz	32A CEE	x						
1 488 029	DYNAJET 350me 440V/60Hz	350	21	400V/60Hz	32A CEE							
1 488 110	DYNAJET 350me 3x200V/50Hz	350	21	440V/60Hz	32A CEE							
1 495 009	DYNAJET 350me 220V/60Hz	350	21	3x200V/50Hz	63A CEE							
1 496 008	DYNAJET 350me 3x220V/60Hz	350	21	3x220V/60Hz	63A CEE							
1 486 005	DYNAJET 350mg	350	21									
1 486 089	DYNAJET 350mg Plus w/ Accessories	350	21									
1 513 010	DYNAJET 350md	350	21					o				
1 513 100	DYNAJET 350md basic	350	21					o			x	
1 492 060	Dynabox 350 12V			12V DC	24V CEE							
1 492 002	Dynabox 350 230V/50Hz			230V/50Hz	Schuko							
1 492 057	Dynabox 350 220V/60Hz			1x220V 50/60Hz	Schuko							
1 492 028	Dynabox 350 1X100V 50/60HZ			1x100V 50/60Hz	Schuko							
1 492 031	Dynabox 350 1X120V 60HZ			1x120V 50/60Hz	Schuko							
1 509 018	DYNAJET 500me 400V/50Hz HELI	500	15	400V/50Hz	32A CEE	x						
1 509 187	DYNAJET 500me 400V/50Hz with basic valve	500	15	400V/50Hz	32A CEE		x					
1 509 096	DYNAJET 500me 400V/50Hz aut. st./d. HELI	500	15	400V/50Hz	32A CEE	x		x				
1 509 148	DYNAJET 500me 400V/50Hz TTS Heli	500	15	400V/50Hz	32A CEE	x		x	x			
1 509 044	DYNAJET 500me 400V/60Hz HELI	500	15	400V/60Hz	32A CEE	x						
1 509 200	DYNAJET 500me 400V/60Hz aut. st./d. HELI	500	15	400V/60Hz	32A CEE	x		x				
1 509 135	DYNAJET 500me 440V/60Hz HELI	500	15	440V/60Hz	32A CEE	x						
1 509 122	DYNAJET 500me Seamaid 440V/60HZ HELI	500	15	440V/60Hz	32A CEE	x						
1 509 070	DYNAJET 500me 3x200V/50Hz HELI	500	15	3x200V/50Hz	63A CEE	x						
1 509 057	DYNAJET 500me 3x220V/60HZ HELI	500	15	3x220V/60Hz	63A CEE	x		x				

		Pressure (bar)	Flow rate (l/min)	Power consumption	Plug	DYNAJET HELI-valve	Basic valve	Spark catcher 1	Automatic star-delta switch	Total start/stop automatic	Manual throttle lever	Cable remote control
x Standard	o Optional feature											
1 486 050	DYNAJET 500mg	500	15			x						
1 486 092	DYNAJET 500mg with basic valve	500	15				x					
1 513 020	DYNAJET 500md HELI	500	15			x		o				
1 513 030	DYNAJET 500MD with basic valve	500	15				x	o				
1 513 200	DYNAJET 500md basic	500	15				x	o			x	
1 518 050	DYNAJET 500 / 30 me 400V/50Hz basic HELI	500	30	400V/50Hz	63A CEE	x			x			
1 518 051	DYNAJET 500 / 30 me 400V/50Hz basic	500	30	400V/50Hz	63A CEE		x		x			
1 518 020	DYNAJET 500me-30 400V/50Hz HELI	500	30	400V/50Hz	63A CEE	x			x			
1 518 021	DYNAJET 500 / 30 me 400V/50Hz EV	500	30	400V/50Hz	63A CEE		x		x			
1 518 070	DYNAJET 500 / 30 me 400V/50Hz TSS	500	30	400V/50Hz	63A CEE		x		x	x		
1 518 040	DYNAJET 500/30me 440V/60Hz HELI	500	30	440V/60Hz	63A CEE	x			x			
1 518 060	DYNAJET 500/30me 440V/60Hz basic HELI	500	30	440V/60Hz	63A CEE	x			x			
1 521 009	Dynabox 500 12V			12V DC	24V CEE							
1 521 022	Dynabox 500 230V/50Hz			230V/50Hz	Schuko							
1 521 035	Dynabox 500 220V/60Hz			220V/60Hz	Schuko							
1 585 010	DYNAJET 800me 400V/50Hz/63A	800	20	400V/50Hz	63A CEE				x			
1 585 020	DYNAJET 800me 440V/60Hz/63A	800	22	440V/60Hz	63A CEE				x			
1 585 050	DYNAJET 1000me 400V/50Hz/63A	1000	17	400V/50Hz	63A CEE				x			
1 585 050	DYNAJET 1000me 400V/50Hz/63A FB	1000	17	400V/50Hz	63A CEE				x			x
1 585 060	DYNAJET 1000me 440V/60Hz/63A	1000	17	440V/60Hz	63A CEE				x			

1) 503 030

DYNAJET Trailer

x Standard o Optional feature

		Pressure (bar)	Flow rate (l/min)	DYNAJET HELI-valve	Basic valve	Vario control	Radio remote control	WiFi Module 1
1 480 010	DYNAJET 350th	350	16		x			
1 480 040	DYNAJET 350th HELI	350	16	x				
1 480 011	Dynajet 249th with ATC	249	21		x	x		
1 480 050	DYNAJET 350th 300/19	300	19		x			
1 480 051	DYNAJET 350th 300bar HELI	300	19	x				
1 480 041	DYNAJET 350th HELI + ATC	350	16	x		x		
1 480 042	DYNAJET 350th HELI+ATC+RC	350	16	x		x	x	
1 480 071	DYNAJET 350th spark arrestor	350	16		x			
1 480 030	DYNAJET 350sh	350	16					
1 480 031	DYNAJET 350sh HELI	350	16	x				
1 490 020	DYNAJET 500th HELI	500	30	x				
1 490 022	DYNAJET 500th HELI with ATC	500	30	x		x		
1 490 090	DYNAJET 500th HELI with ATC + RC	500	30	x		x	x	
1 490 070	DYNAJET 500th HELI special	500	30	x				
1 490 041	DYNAJET 500t - 30L HELI	500	30	x				
1 490 042	DYNAJET 500t - 30L HELI with ATC + RC	500	30	x		x	x	
1 490 040	DYNAJET 500t HELI 400/37	400	37	x				
1 490 030	DYNAJET 500sh HELI	500	30	x				
1 490 031	DYNAJET 500 SH HELI	400	37	x				
1 490 034	DYNAJET 500sh HELI special	500	30	x				
1 490 032	DYNAJET 500sh HELI special ATC RC	500	30	x		x	x	
1 529 010	DYNAJET 800th	800	21			x		
1 529 080	DYNAJET 800th wireless	800	21					
1 529 081	DYNAJET 800th wireless special	800	21					
1 529 090	DYNAJET 800th wl, ATC, RC	800	21			x	x	
1 529 040	DYNAJET 800t wireless	800	21					
1 529 033	DYNAJET 800sh wireless	800	21					
1 529 032	DYNAJET 800sh wireless special	800	21					
1 529 031	DYNAJET 800s wireless	800	21					
1 573 040	DYNAJET 1000t wireless	1.000	17					
1 610 160	DYNAJET UHP 220 800/88 Tier2	800	88					o
1 610 010	DYNAJET UHP 220 1200/64 t	1.200	64					o
1 610 030	DYNAJET UHP 220 2200/36 t	2.200	36					o
1 610 040	DYNAJET UHP220 2800 t	2.800	27					o
1 610 140	DYNAJET UHP220 2800 s	2.800	27					o
1 610 041	DYNAJET UHP 220 2800/27 Tier2	2.800	27					o
1 610 070	DYNAJET UHP 220 3000/24 t	3.000	24					o

DYNAJET – Always at your service!

You're interested in a specific DYNAJET product, would like to arrange a date for a free demonstration or have a question about DYNAJET or our product assortment? We'd be pleased to help you. Whether it's online, by phone or in person – you have the choice:



Our web site:

www.dyna-jet.com

DYNAJET dealer search:

www.dyna-jet.com/dealers

DYNAJET address and contact information:

DYNAJET GmbH
Wilhelm-Maybach-Str. 2
72622 Nürtingen
Germany

Tel.: +49-(0)7022-30411-30

Fax: +49-(0)7022-30411-50

E-mail: info@dynajet.de



DYNAJET

DYNAJET GmbH

Wilhelm-Maybach-Str. 2
72622 Nürtingen
Germany

Tel.: +49-(0)7022-30411-30

Fax: +49-(0)7022-30411-50

Web site: www.dyna-jet.com

E-mail: info@dyna-jet.de

© DYNAJET GmbH, 2016

Misprints and errors excepted.

Subject to changes without notification.

The logo for DYNAJET features the word "DYNAJET" in a bold, black, sans-serif font. To the left of the first few letters, there is a blue graphic element consisting of a triangle pointing to the right, with a white diagonal line cutting through it from the top-left to the bottom-right.